

Spindle ball bearing HY S 61904 C TXM P4+

16.07.2024



Components

Bearing designation:	HY S 61904 C TXM
Bearing design:	S
Series / size:	61904
Ball material:	Ceramic
Cage:	TXM
Precision:	P4+
Main dimensions [d x D x B]:	20 x 37 x 9 mm

Load data

Static load capacity	C_{0r} : 4400 N
Dynamic load capacity	C_r : 7250 N
Fatigue load limit	C_U : 167 N
Speed limit	n_{grease} : 56250 1/min
Speed limit	n_{oil} : 75000 1/min
Light preload	L: 35 N
Axial rigidity	C_{ax} : 28 N/ μ m
Medium preload	M: 110 N
Axial rigidity	C_{ax} : 47 N/ μ m
Heavy preload	S: 220 N
Axial rigidity	C_{ax} : 65 N/ μ m
Spring preload	Ff: 180 N (for n_{max})

Geometrical Data

Bore diameter	d: 20 mm	Oiling nozzle position	d_T : 26.9 mm
Outer diameter	D: 37 mm	Pitch circle diameter	d_m : 28.5 mm
Width of single bearing	B: 9 mm	Inner diameter of outer ring	D_1 : 31.9 mm
Ball diameter	D_w : 4.762 mm	Undercut of associated component	$r_{a max}$: 0.3 mm
Number of balls	Z: 15	Undercut of associated component (open side)	$r_{b max}$: 0.3 mm
Chamfer (min)	$r_{1,2 min}$: 0.3 mm	Abutment diameter inner ring	$d_{a,b min}$: 22.5 mm
Chamfer (min), open side	$r_{3,4 min}$: 0.3 mm	Abutment diameter outer ring	$D_{a,b max}$: 35.1 mm
Outer diameter of inner ring	d_1 : 25.1 mm	Inner diameter of outer ring (open side)	D_2 : 33.3 mm
Outer diameter of inner ring (open side)	d_2 : -	Bearing weight	m: 0.03 kg
		Contact angle	Alpha 0: 15°

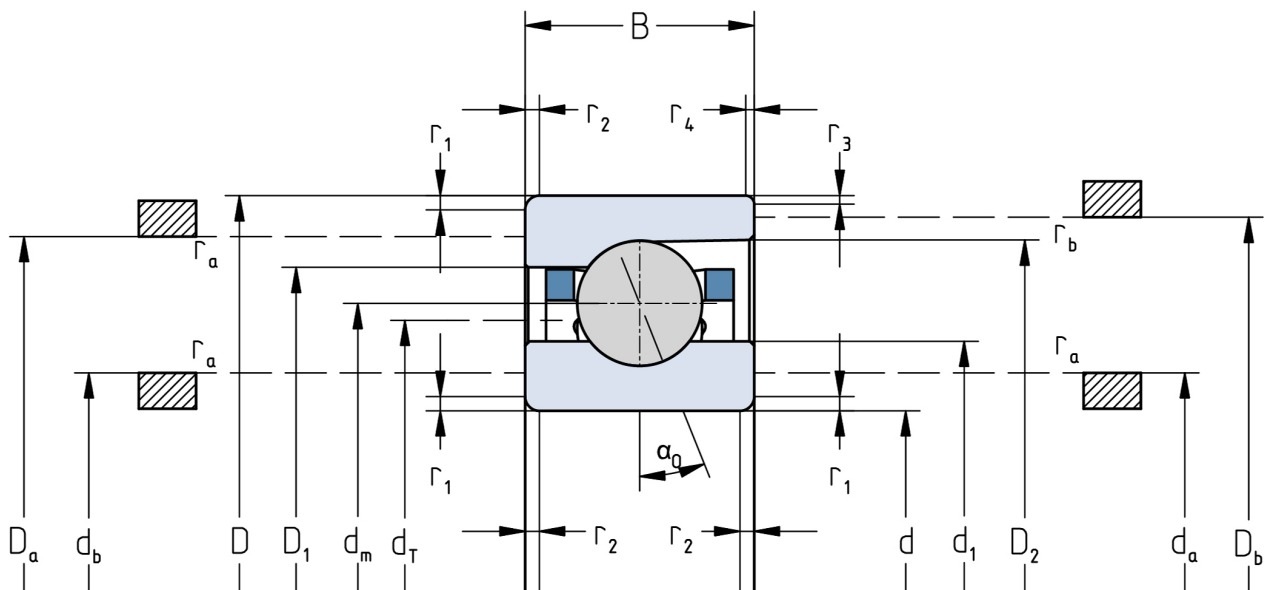

The given speed limits apply to individual bearings with spring preload. Correction factors must be considered for all properties which deviate from this.