

HSP 120g - 30000/6



Grinding quills

Semi-finished goods

GMN semi-finished products allow the individual adaptation of the tool interface for any connections.

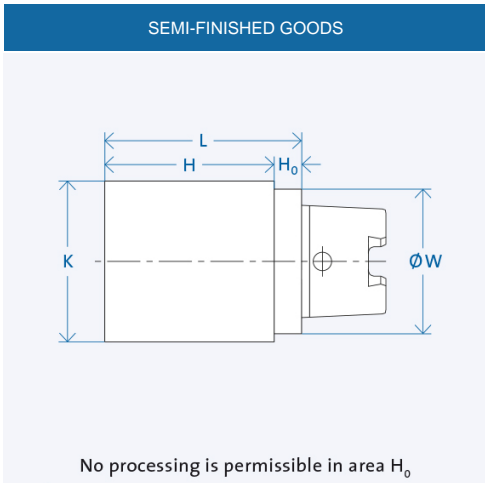

Interface	W [mm]	K [mm]	H [mm]	L [mm]	H ₀ [mm]	Wgt.[kg]
HSK-C25	25	30	90	100	10	1
HSK-C32	32	41	139	150	11	1,50
HSK-C40	40	51	169	180	11	2,81
HSK-C50	50	64	186	200	14	4,92
HSK-C50	50	64	76	90	14	2,15
HSK-C63	63	81	186	200	14	7,90
HSK-C63	63	81	86	100	14	3,89
HSK-C80	80	101	193	210	17	12,90
HSK-C100	100	124	208	225	17	21,70

Ordering information "Semi-finished Product" [mandrel Ø K] x [mandrel length H] [interface]

Example: Semi-finished goods 81 x 186 HSK-C63

The various shapes differ with respect to pusher dog recess and collar. Taper hollow shafts (HSK) with flat contact faces are standardized per DIN 69893. Spindles in type series HSP/HV-P can accept tools with taper hollow shafts of form A and C. Form C has been especially developed for use with manual tool change systems. In contrast, form A is equipped with a gripper groove for automatic tool change systems. This means, form A can also be used with manual tool change system provided in the HSP- and HV-P style spindles. As a result, it is often possible to limit the range of tools when there are other automatic tool change systems in use. Tools according to Form B, D, E and F cannot be used in the HSP/HV-P spindles. They are designed for different applications. The HSK interface allows these spindles to be operated in both directions of rotation.



Lubrication system

The electronically controlled PRELUB lubrication unit is optimally adapted to the oil-air lubricated GMN spindles and guarantees a long service life.



Cooling system

GMN cooling units ensure precisely adjustable temperature and quantity delivery of the coolant and achieve consistently low operating temperatures.



Cable and plug

Ready-made cables with B048, B049, GA, MAC, D500 and STK plugs are available on request. For the spindle/converter connection, GMN supplies UL/CSA approved electrical cables suitable for use in drag chains.