

Spindle ball bearing SM 61921 C TA P4+

16.07.2024



Components

Bearing designation:	SM 61921 C TA
Bearing design:	SM
Series / size:	61921
Ball material:	Steel 100Cr6
Cage:	TA
Seal:	2RZ upon request
Precision:	P4+
Main dimensions [d x D x B]:	105 x 145 x 20 mm

Load data

Static load capacity	C_{0r} : 33000 N
Dynamic load capacity	C_r : 38500 N
Fatigue load limit	C_U : 1516 N
Speed limit	n_{grease} : 12000 1/min
Speed limit	n_{oil} : 16000 1/min
Light preload	L: 200 N
Axial rigidity	C_{ax} : 111 N/ μ m
Medium preload	M: 590 N
Axial rigidity	C_{ax} : 165 N/ μ m
Heavy preload	S: 1170 N
Axial rigidity	C_{ax} : 216 N/ μ m
Spring preload	Ff: 2120 N (for n_{max})

Geometrical Data

Bore diameter	d: 105 mm	Oiling nozzle position	d_f : 121.5 mm
Outer diameter	D: 145 mm	Pitch circle diameter	d_m : 125 mm
Width of single bearing	B: 20 mm	Inner diameter of outer ring	D_1 : 132.2 mm
Ball diameter	D_w : 11.906 mm	Undercut of associated component	$r_{a \max}$: 0.6 mm
Number of balls	Z: 26	Undercut of associated component (open side)	$r_{b \max}$: 0.6 mm
Chamfer (min)	$r_{1,2 \min}$: 0.6 mm	Abutment diameter inner ring	$d_{a,b \min}$: 110.7 mm
Chamfer (min), open side	$r_{3,4 \min}$: 0.6 mm	Abutment diameter outer ring	$D_{a,b \max}$: 140.2 mm
Outer diameter of inner ring	d_1 : 117.8 mm	Inner diameter of outer ring (open side)	D_2 : 137.1 mm
Outer diameter of inner ring (open side)	d_2 : -	Bearing weight	m: 0.82 kg
		Contact angle	Alpha 0: 19°

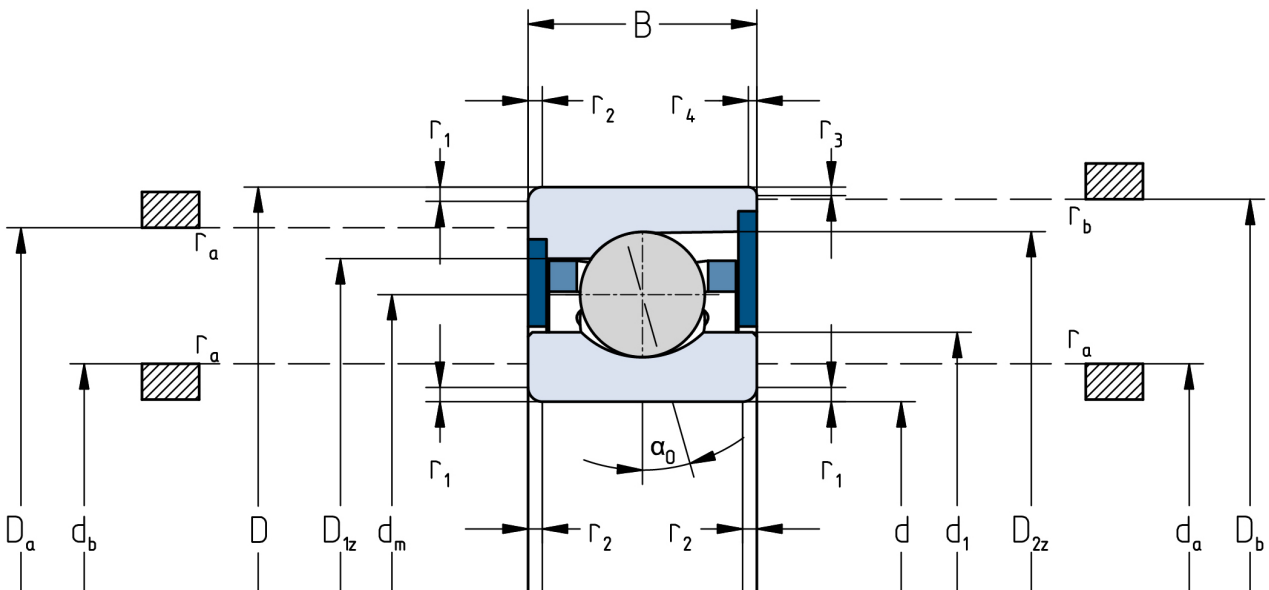

The given speed limits apply to individual bearings with spring preload. Correction factors must be considered for all properties which deviate from this.