

# Labyrinth Metal Seal Type L



L 100 X 120 X 10

Item number 301278

## Technical data

Outer ring material*:	Aluminum (GD AISi 12)
Inner ring material:	Unalloyed construction steel
Inner diameter ID:	100 mm
Outer diameter OD:	120 mm
Installed width W:	10 mm
Sealing gap:	Horizontal
Axial play $S_{ax}$ **:	0.42 mm
Radial play $S_{rad}$ **:	$S_{rad} = S_{ax} / \tan(42,5^\circ)$
Gap diameter e:	115 mm
Gap height:	Constant 0,2– 0,5 mm (depending upon size)
Speed limit:	10500 rpm
Weight:	0.1935 kg
Operating temperature t:	-40° - 200°C

Axial play:

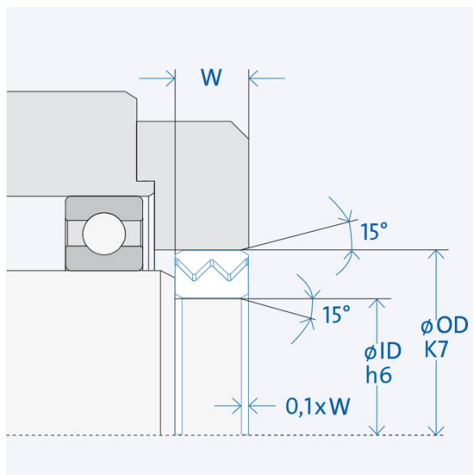
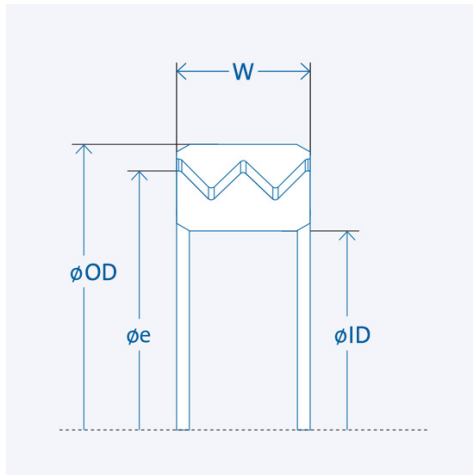
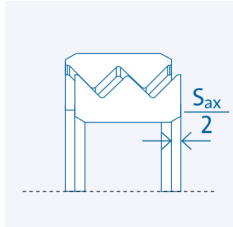

\*Aluminum outer ring

The aluminum outer ring can be slightly non-round as supplied. By pressing in the seal, the relatively easily deformable ring fits the roundness of the hub.

The outer ring can be up to 0.1 mm wider than the inner ring due to manufacturing. GMN metal labyrinth seals are pressed through a calibration ring ('zero dimension'). The outer ring then springs back due to its elasticity.

\*\*Entire movability from one end position to the other.

## Installation

"l" Length (chamfering of shaft and housing) depending on the width W:  $l = 0,1 \times B$

## Component tolerances

Surrounding structure (mating parts)

Housing: K7 / Shaft: h6

Surface quality:  $Rz \leq 16 \mu\text{m}$ ;  $Ra \leq 3,2 \mu\text{m}$