

TSA 50 x 250

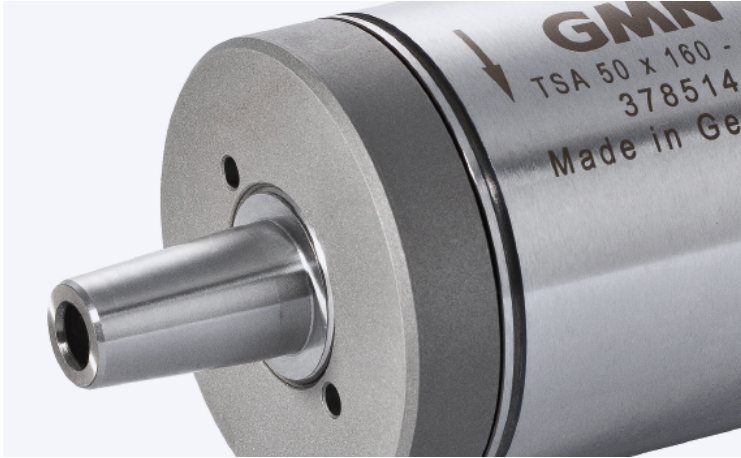

Technical data

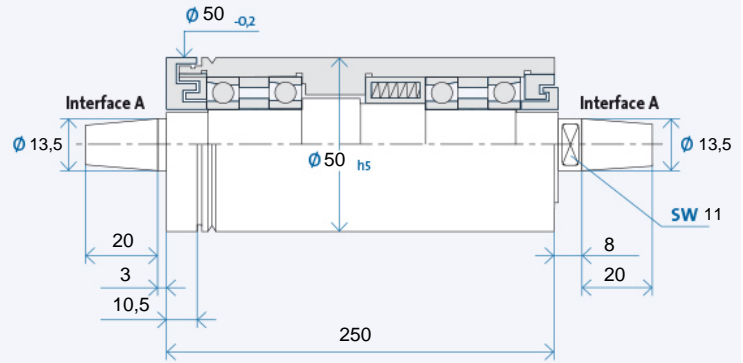

Maximum speed n_{max} [min-1]* for bearing types:	
Steel (steel)	35000
Hybrid (optional)	42000

* without tool

Ordering information: TSA 50 x 250 R is for clockwise, L for counter-clockwise

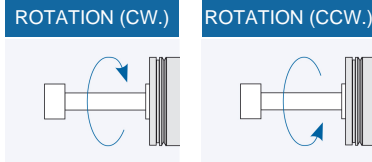

Tool interface

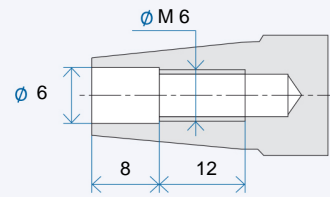

Tool interface: taper 1 : 7,5 nominal value, included angle acc. to GMN precision standards

Pulley interface

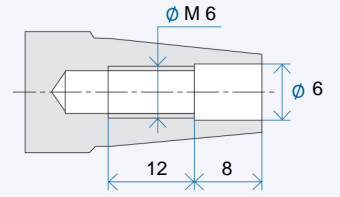

Pulley interface: taper 1 : 7,5 nominal value, included angle acc. to GMN precision standards

Accessories

TSA Grinding wheel flanges

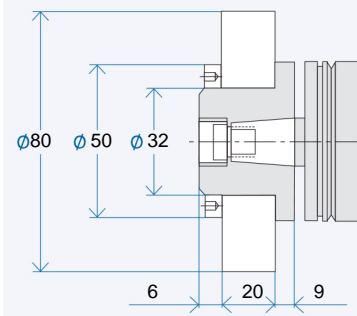

Ordering information flange: AX₁/X₂/X₃
 X₁: Interface: 07/08/...
 X₂: Flange style: MO/MS
 X₃: Wheel:
 K = Corundum grinding wheel
 D = Diamond or CBN grinding wheel
 Puller for flange: AX₁/X₂
 Balancing quill for flange: AX₁

Pulleys

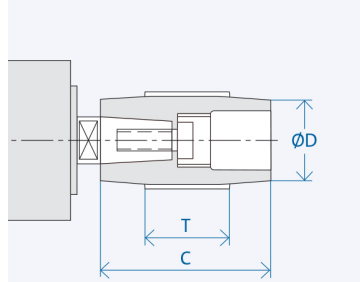

Interface	Dimensions [mm]		
	D	C	T
A 13	20	50	30
	25	50	30
	32	50	30
	80	50	30

Ordering information pulley: AX₁-X₂
 X₁: Interface: 07/08/...
 X₂: Figure from column D
 Puller for pulley: AX₁/...

TSA Collet chuck

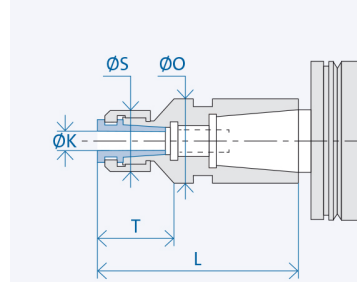

Interface	Dimensions [mm]				
	K	T	L	S	O
A 13	3	15,5	47	16	18
	4	15,5	47	16	18
	5	15,5	47	16	18
	6	15,5	47	16	18

Ordering information collet chuck: AX₁/X₂-(K)
 X₁: Interface: 07/08/...
 X₂: Housing diameter: 20/26/...
 (K) = Inner diameter collet chuck

TSA Grinding quill – semifinished

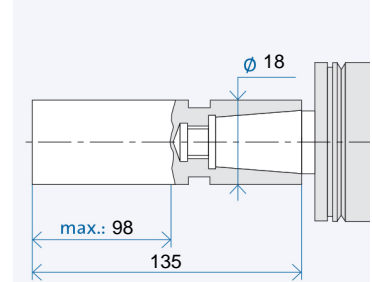

Ordering information semifinished: AX₁
 X₁: Interface 10/13/...