

TSP 40 x 200

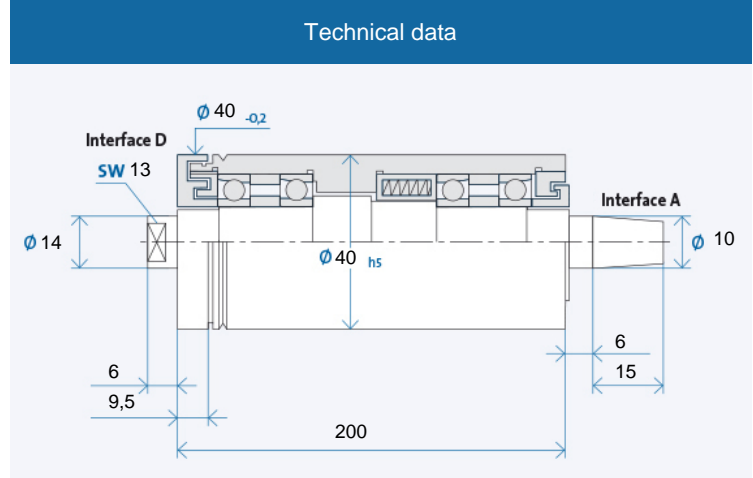

Maximum speed n_{max} [min ⁻¹]* for bearing types:	
Steel (steel)	45000
Hybrid (optional)	55000

* without tool

Ordering information: TSP 40 x 200 R is for clockwise, L for counter-clockwise

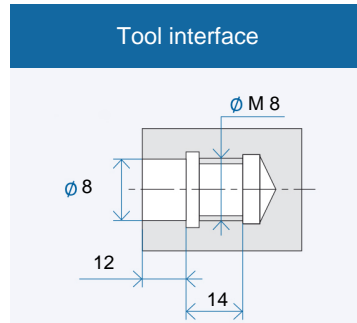
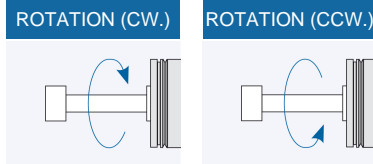

Tool interface: fitting bores with flat contact face acc. to GMN precision standards

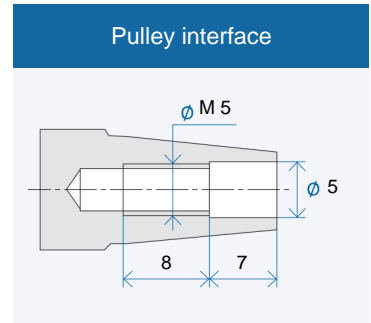

Pulley interface: taper 1 : 7,5 nominal value, included angle acc. to GMN precision standards

Accessories

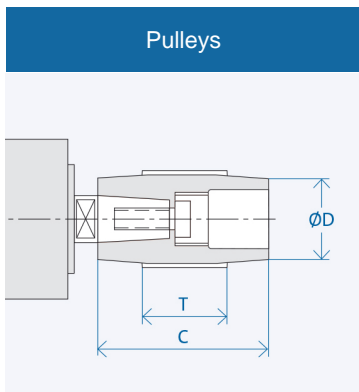

Interface	Dimensions [mm]		
	D	C	T
A 10	18	30	20
	50	30	20
	17	40	20
	20	40	20
	25	40	20
	63	40	20

Ordering information pulley: AX₁-X₂
 X₁: Interface: 10/13/...
 X₂: Figure from column D
 Puller for pulley: AX₁/...

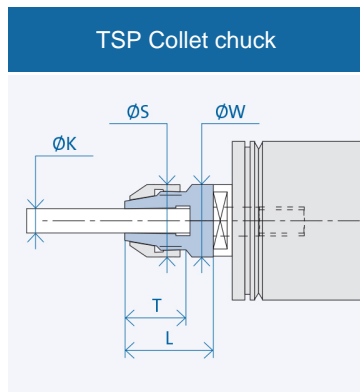

Interface	Dimensions [mm]					
	K	T	L	S	W	
D 08/14	3	20	26	14	14	

Ordering information collet chuck: D 08/14/(K)
 (K) = Clamping diameter

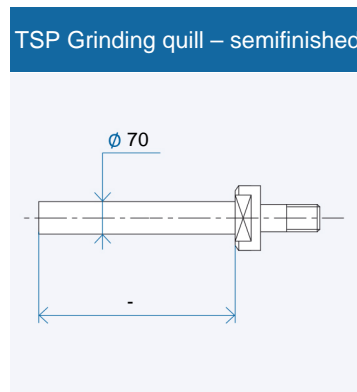

Ordering information semifinished: DX₁/X₂
 X₁/X₂: Interface 08/14/...

This data sheet reflects the state of information at the time of printing. Subject to technical changes. Information on possible options can be obtained from our catalogue which can be downloaded at www.gmn.de