

# Spindle ball bearing HY S 61916 E TA P4+

16.07.2024



## Components

Bearing designation:	HY S 61916 E TA
Bearing design:	S
Series / size:	61916
Ball material:	Ceramic
Cage:	TA
Seal:	2RZ upon request
Precision:	P4+
Main dimensions [d x D x B]:	80 x 110 x 16 mm

## Load data

Static load capacity	$C_{0r}$ : 35000 N
Dynamic load capacity	$C_r$ : 33500 N
Fatigue load limit	$C_U$ : 1322 N
Speed limit	$n_{grease}$ : 14250 1/min
Speed limit	$n_{oil}$ : 19000 1/min
Light preload	L: 280 N
Axial rigidity	$C_{ax}$ : 219 N/ $\mu$ m
Medium preload	M: 840 N
Axial rigidity	$C_{ax}$ : 331 N/ $\mu$ m
Heavy preload	S: 1680 N
Axial rigidity	$C_{ax}$ : 436 N/ $\mu$ m
Spring preload	Ff: 2510 N (for $n_{max}$ )

## Geometrical Data

Bore diameter	d: 80 mm	Oiling nozzle position	$d_f$ : 92.3 mm
Outer diameter	D: 110 mm	Pitch circle diameter	$d_m$ : 95 mm
Width of single bearing	B: 16 mm	Inner diameter of outer ring	$D_1$ : 100.8 mm
Ball diameter	$D_w$ : 9.525 mm	Undercut of associated component	$r_{a \max}$ : 0.6 mm
Number of balls	Z: 25	Undercut of associated component (open side)	$r_{b \max}$ : 0.3 mm
Chamfer (min)	$r_{1,2 \min}$ : 0.6 mm	Abutment diameter inner ring	$d_{a,b \min}$ : 84.9 mm
Chamfer (min), open side	$r_{3,4 \min}$ : 0.3 mm	Abutment diameter outer ring	$D_{a,b \max}$ : 105.7 mm
Outer diameter of inner ring	$d_1$ : 89.4 mm	Inner diameter of outer ring (open side)	$D_2$ : 104.6 mm
Outer diameter of inner ring (open side)	$d_2$ : -	Bearing weight	m: 0.31 kg
		Contact angle	Alpha 0: 25°

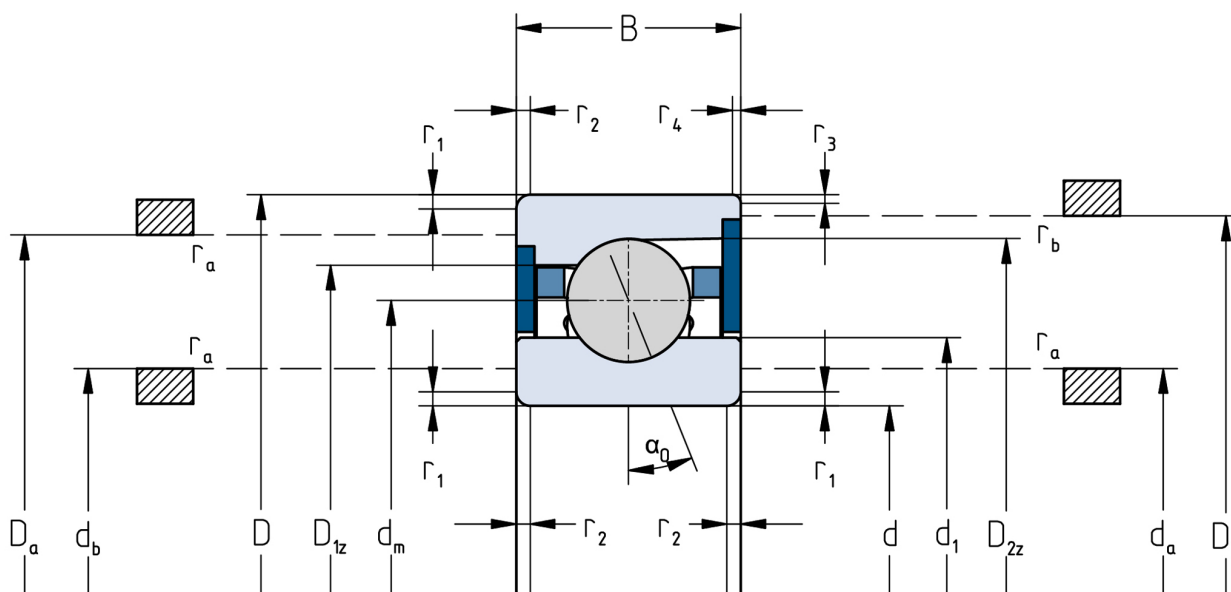

The given speed limits apply to individual bearings with spring preload. Correction factors must be considered for all properties which deviate from this.