

# Spindle ball bearing KH 61904 E TA P4+

16.07.2024



## Components

Bearing designation:	KH 61904 E TA
Bearing design:	KH
Series / size:	61904
Ball material:	Steel 100Cr6
Cage:	TA
Seal:	2RZ optional (with grease)
Precision:	P4+
Main dimensions [d x D x B]:	20 x 37 x 9 mm

## Load data

Static load capacity	$C_{0r}$ : 1840 N
Dynamic load capacity	$C_r$ : 3700 N
Fatigue load limit	$C_U$ : 96 N
Speed limit	$n_{grease}$ : 51000 1/min
Speed limit	$n_{oil}$ : 68000 1/min
Light preload	L: 30 N
Axial rigidity	$C_{ax}$ : 44 N/ $\mu$ m
Medium preload	M: 90 N
Axial rigidity	$C_{ax}$ : 66 N/ $\mu$ m
Heavy preload	S: 180 N
Axial rigidity	$C_{ax}$ : 85 N/ $\mu$ m
Spring preload	Ff: 180 N (for $n_{max}$ )

## Geometrical Data

Bore diameter	d: 20 mm	Oiling nozzle position	$d_7$ : 26.6 mm
Outer diameter	D: 37 mm	Pitch circle diameter	$d_m$ : 27.9 mm
Width of single bearing	B: 9 mm	Inner diameter of outer ring	$D_1$ : 30.7 mm
Ball diameter	$D_w$ : 3.969 mm	Undercut of associated component	$r_{a max}$ : 0.3 mm
Number of balls	Z: 16	Undercut of associated component (open side)	$r_{b max}$ : 0.3 mm
Chamfer (min)	$r_{1,2 min}$ : 0.3 mm	Abutment diameter inner ring	$d_{a,b min}$ : 22.1 mm
Chamfer (min), open side	$r_{3,4 min}$ : 0.3 mm	Abutment diameter outer ring	$D_{a,b max}$ : 35.4 mm
Outer diameter of inner ring	$d_1$ : 25.1 mm	Inner diameter of outer ring (open side)	$D_2$ : 32 mm
Outer diameter of inner ring (open side)	$d_2$ : 24.5 mm	Bearing weight	m: 0.036 kg
		Contact angle	Alpha 0: 25°

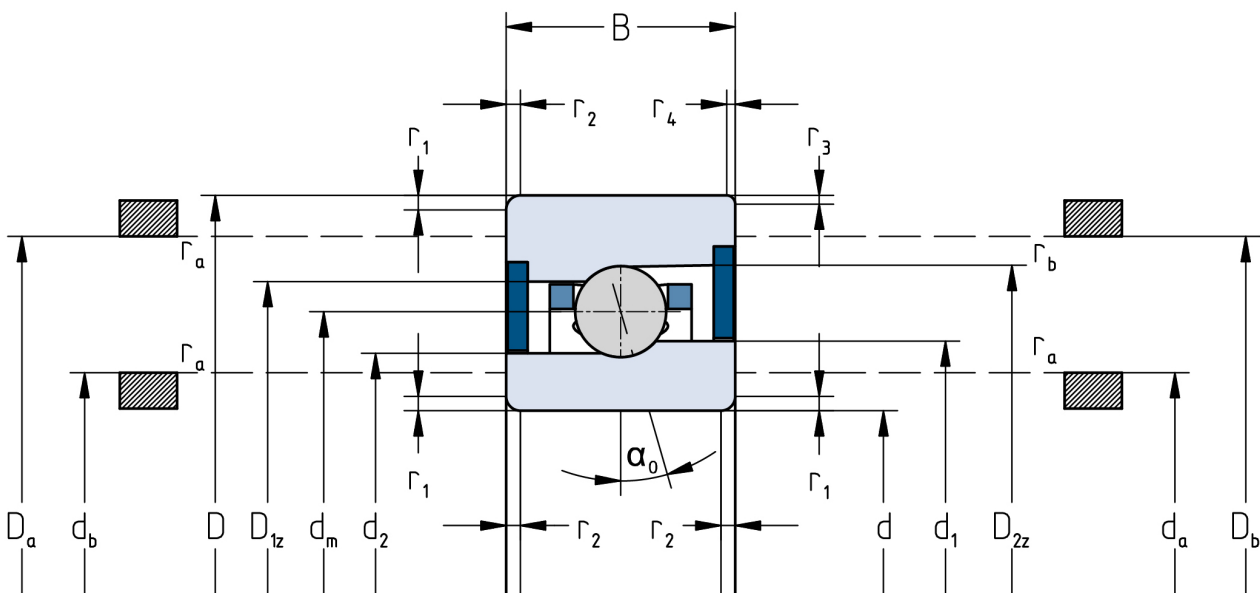

The given speed limits apply to individual bearings with spring preload. Correction factors must be considered for all properties which deviate from this.