

Spindle ball bearing S 61905 C TA P4+

16.07.2024



Components

Bearing designation:	S 61905 C TA
Bearing design:	S
Series / size:	61905
Ball material:	Steel 100Cr6
Cage:	TA
Precision:	P4+
Main dimensions [d x D x B]:	25 x 42 x 9 mm

Load data

Static load capacity	C_{0r} : 5450 N
Dynamic load capacity	C_r : 7700 N
Fatigue load limit	C_U : 282 N
Speed limit	n_{grease} : 37500 1/min
Speed limit	n_{oil} : 50000 1/min
Light preload	L: 40 N
Axial rigidity	C_{ax} : 29 N/ μ m
Medium preload	M: 120 N
Axial rigidity	C_{ax} : 48 N/ μ m
Heavy preload	S: 240 N
Axial rigidity	C_{ax} : 67 N/ μ m
Spring preload	Ff: 310 N (for n_{max})

Geometrical Data

Bore diameter	d: 25 mm	Oiling nozzle position	d_T : 32.4 mm
Outer diameter	D: 42 mm	Pitch circle diameter	d_m : 34 mm
Width of single bearing	B: 9 mm	Inner diameter of outer ring	D_1 : 37.4 mm
Ball diameter	D_w : 4.762 mm	Undercut of associated component	$r_{a \max}$: 0.3 mm
Number of balls	Z: 17	Undercut of associated component (open side)	$r_{b \max}$: 0.3 mm
Chamfer (min)	$r_{1,2 \min}$: 0.3 mm	Abutment diameter inner ring	$d_{a,b \min}$: 27.4 mm
Chamfer (min), open side	$r_{3,4 \min}$: 0.3 mm	Abutment diameter outer ring	$D_{a,b \max}$: 40.1 mm
Outer diameter of inner ring	d_1 : 30.6 mm	Inner diameter of outer ring (open side)	D_2 : 38.8 mm
Outer diameter of inner ring (open side)	d_2 : -	Bearing weight	m: 0.04 kg
		Contact angle	Alpha 0: 15°

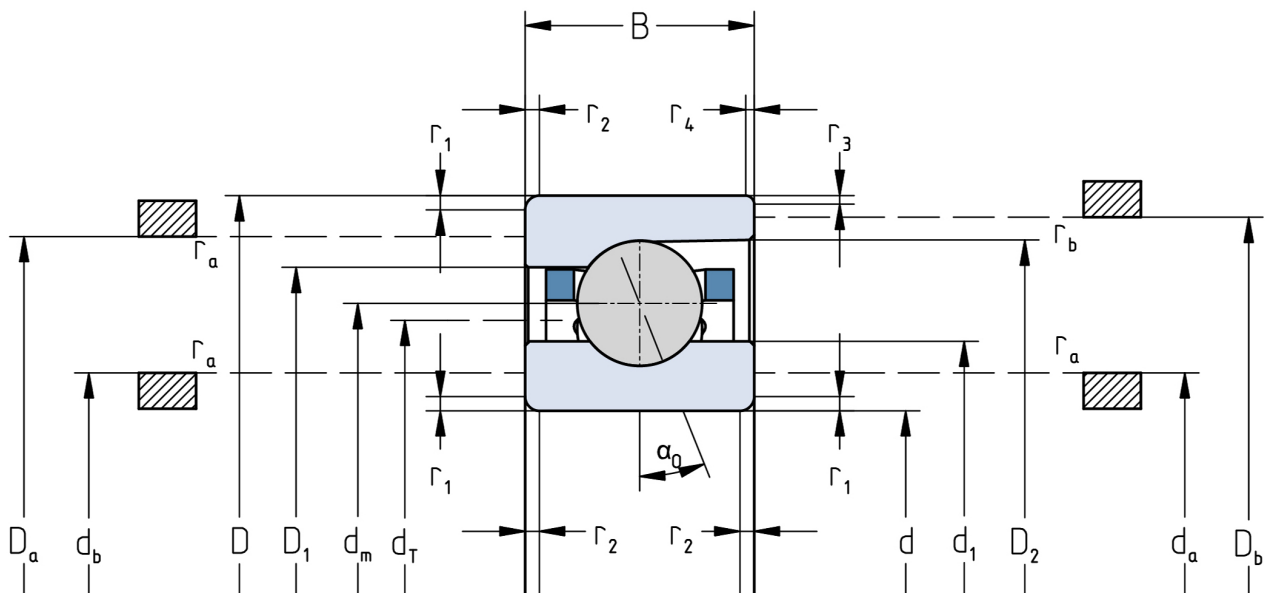

The given speed limits apply to individual bearings with spring preload. Correction factors must be considered for all properties which deviate from this.