

TSP 80 x 315

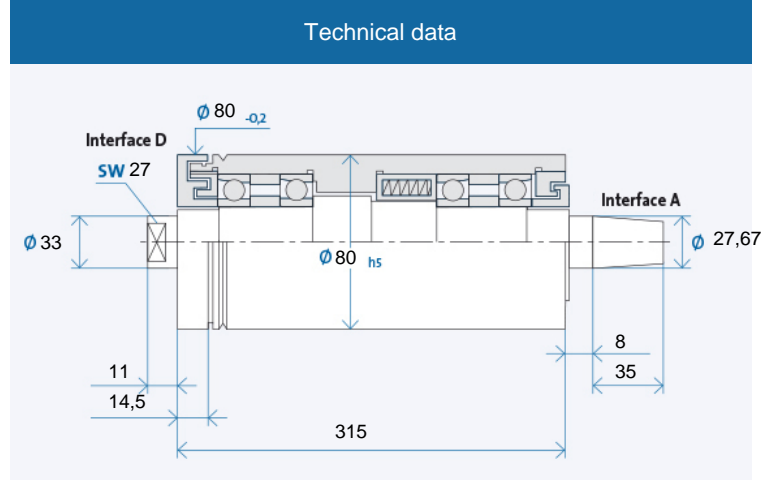

Maximum speed n_{max} [min-1]* for bearing types:	
Steel (steel)	20000
Hybrid (optional)	25000

* without tool

Ordering information: TSP 80 x 315 R is for clockwise, L for counter-clockwise

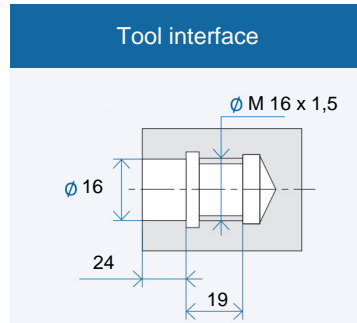
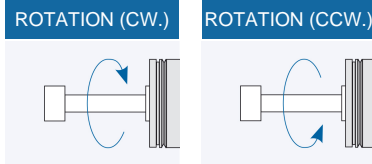

Tool interface: fitting bores with flat contact face acc. to GMN precision standards

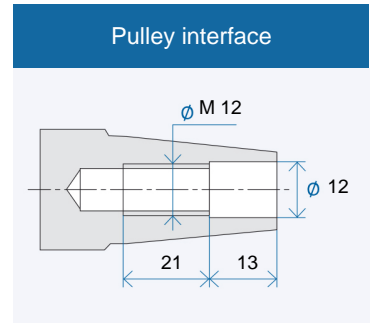

Pulley interface: taper 1 : 7,5 nominal value, included angle acc. to GMN precision standards

Accessories

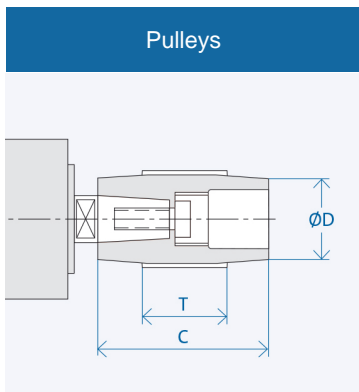

Interface	Dimensions [mm]		
	D	C	T
A 27	40	70	50
	45	70	50
	50	70	50
	56	70	50
	125	70	50

Ordering information pulley: AX₁-X₂

X₁: Interface: 10/13/...

X₂: Figure from column D

Puller for pulley: AX₁/...

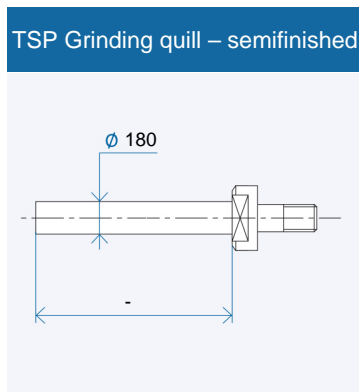

Ordering information semifinished: DX₁/X₂
X₁/X₂: Interface 08/14/...