

Spindle ball bearing KH 6004 C TA P4+

16.07.2024



Components

Bearing designation:	KH 6004 C TA
Bearing design:	KH
Series / size:	6004
Ball material:	Steel 100Cr6
Cage:	TA
Seal:	2RZ optional (with grease)
Precision:	P4+
Main dimensions [d x D x B]:	20 x 42 x 12 mm

Load data

Static load capacity	C_{0r} : 3100 N
Dynamic load capacity	C_r : 6500 N
Fatigue load limit	C_U : 160 N
Speed limit	n_{grease} : 52500 1/min
Speed limit	n_{oil} : 70000 1/min
Light preload	L: 35 N
Axial rigidity	C_{ax} : 27 N/ μ m
Medium preload	M: 100 N
Axial rigidity	C_{ax} : 40 N/ μ m
Heavy preload	S: 200 N
Axial rigidity	C_{ax} : 54 N/ μ m
Spring preload	Ff: 200 N (for n_{max})

Geometrical Data

Bore diameter	d: 20 mm	Oiling nozzle position	d_7 : 28.6 mm
Outer diameter	D: 42 mm	Pitch circle diameter	d_m : 30.2 mm
Width of single bearing	B: 12 mm	Inner diameter of outer ring	D_1 : 34.3 mm
Ball diameter	D_w : 5.556 mm	Undercut of associated component	$r_{a max}$: 0.6 mm
Number of balls	Z: 14	Undercut of associated component (open side)	$r_{b max}$: 0.3 mm
Chamfer (min)	$r_{1,2 min}$: 0.6 mm	Abutment diameter inner ring	$d_{a,b min}$: 23.5 mm
Chamfer (min), open side	$r_{3,4 min}$: 0.3 mm	Abutment diameter outer ring	$D_{a,b max}$: 39.3 mm
Outer diameter of inner ring	d_1 : 26.6 mm	Inner diameter of outer ring (open side)	D_2 : 35.9 mm
Outer diameter of inner ring (open side)	d_2 : 25.3 mm	Bearing weight	m: 0.067 kg
		Contact angle	Alpha 0: 17°

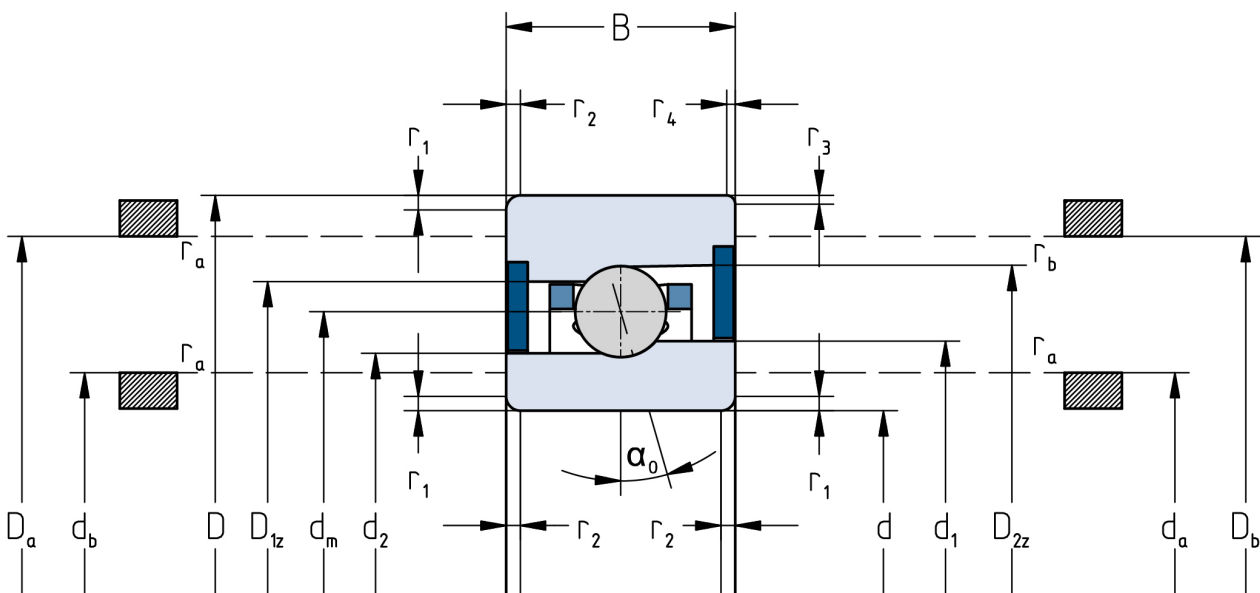

The given speed limits apply to individual bearings with spring preload. Correction factors must be considered for all properties which deviate from this.