

Spindle ball bearing HY KH 61906 C TA P4+

16.07.2024



Components

Bearing designation:	HY KH 61906 C TA
Bearing design:	KH
Series / size:	61906
Ball material:	Ceramic
Cage:	TA
Seal:	2RZ optional (with grease)
Precision:	P4+
Main dimensions [d x D x B]:	30 x 47 x 9 mm

Load data

Static load capacity	C_{0r} : 2650 N
Dynamic load capacity	C_r : 4650 N
Fatigue load limit	C_U : 100 N
Speed limit	n_{grease} : 51750 1/min
Speed limit	n_{oil} : 69000 1/min
Light preload	L: 23 N
Axial rigidity	C_{ax} : 31 N/ μ m
Medium preload	M: 70 N
Axial rigidity	C_{ax} : 47 N/ μ m
Heavy preload	S: 140 N
Axial rigidity	C_{ax} : 62 N/ μ m
Spring preload	Ff: 120 N (for n_{max})

Geometrical Data

Bore diameter	d: 30 mm	Oiling nozzle position	d_7 : 36.5 mm
Outer diameter	D: 47 mm	Pitch circle diameter	d_m : 37.9 mm
Width of single bearing	B: 9 mm	Inner diameter of outer ring	D_1 : 40.7 mm
Ball diameter	D_w : 3.969 mm	Undercut of associated component	$r_{a max}$: 0.3 mm
Number of balls	Z: 22	Undercut of associated component (open side)	$r_{b max}$: 0.3 mm
Chamfer (min)	$r_{1,2 min}$: 0.3 mm	Abutment diameter inner ring	$d_{a,b min}$: 32.1 mm
Chamfer (min), open side	$r_{3,4 min}$: 0.3 mm	Abutment diameter outer ring	$D_{a,b max}$: 45.3 mm
Outer diameter of inner ring	d_1 : 35.1 mm	Inner diameter of outer ring (open side)	D_2 : 42 mm
Outer diameter of inner ring (open side)	d_2 : 34.5 mm	Bearing weight	m: 0.046 kg
		Contact angle	Alpha 0: 17°

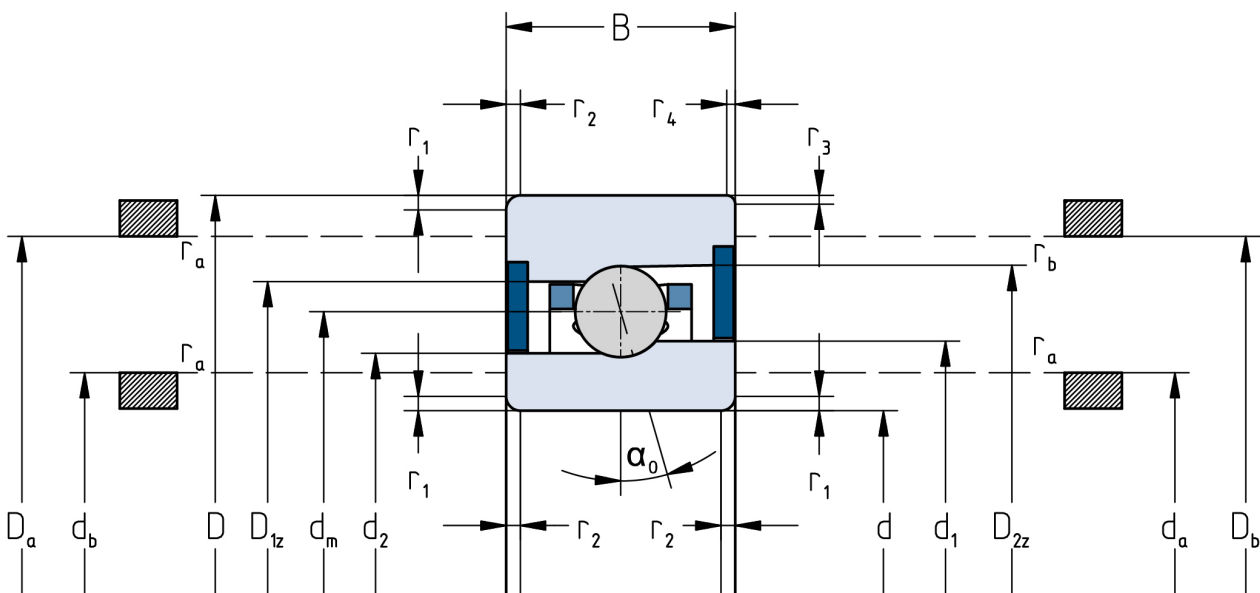

The given speed limits apply to individual bearings with spring preload. Correction factors must be considered for all properties which deviate from this.