

Spindle ball bearing HY SM 61917 C TA P4+

16.07.2024



Components

Bearing designation:	HY SM 61917 C TA
Bearing design:	SM
Series / size:	61917
Ball material:	Ceramic
Cage:	TA
Seal:	2RZ upon request
Precision:	P4+
Main dimensions [d x D x B]:	85 x 120 x 18 mm

Load data

Static load capacity	C_{0r} : 22400 N
Dynamic load capacity	C_r : 29500 N
Fatigue load limit	C_U : 838 N
Speed limit	n_{grease} : 18375 1/min
Speed limit	n_{oil} : 24500 1/min
Light preload	L: 150 N
Axial rigidity	C_{ax} : 104 N/ μ m
Medium preload	M: 440 N
Axial rigidity	C_{ax} : 154 N/ μ m
Heavy preload	S: 890 N
Axial rigidity	C_{ax} : 202 N/ μ m
Spring preload	Ff: 1170 N (for n_{max})

Geometrical Data

Bore diameter	d: 85 mm	Oiling nozzle position	d_f : 99.4 mm
Outer diameter	D: 120 mm	Pitch circle diameter	d_m : 102.5 mm
Width of single bearing	B: 18 mm	Inner diameter of outer ring	D_1 : 108.8 mm
Ball diameter	D_w : 10.319 mm	Undercut of associated component	$r_{a max}$: 0.6 mm
Number of balls	Z: 25	Undercut of associated component (open side)	$r_{b max}$: 0.6 mm
Chamfer (min)	$r_{1,2 min}$: 0.6 mm	Abutment diameter inner ring	$d_{a,b min}$: 90.2 mm
Chamfer (min), open side	$r_{3,4 min}$: 0.6 mm	Abutment diameter outer ring	$D_{a,b max}$: 115.6 mm
Outer diameter of inner ring	d_1 : 96.2 mm	Inner diameter of outer ring (open side)	D_2 : 113 mm
Outer diameter of inner ring (open side)	d_2 : -	Bearing weight	m: 0.46 kg
		Contact angle	Alpha 0: 19°

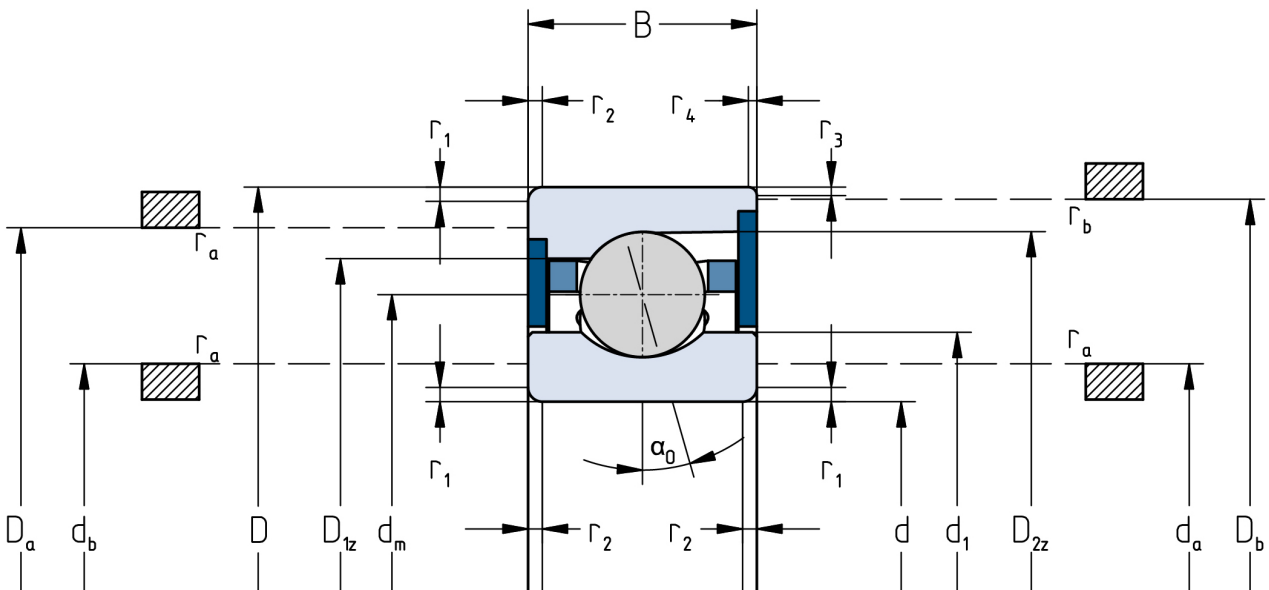

The given speed limits apply to individual bearings with spring preload. Correction factors must be considered for all properties which deviate from this.