

HV-X 100 - 30000/9

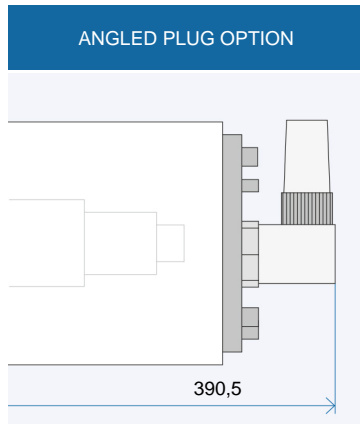

Technical data		
∅ Spindle housing	A	[mm]
Speed max.	n_{max}	[min ⁻¹]
Bearing; front	W_1	[mm]
Tool interface		
∅ Flat layout	W	[mm]
Static rigidity		
axial	C_{ax}	[N/μm]
radial	C_{rad}	[N/μm]
Motor realization		
Frequency max.	f_{max}	[Hz]
Converter voltage ¹⁾		[V]
Power	P_{S1}	[kW]
Torque	M_{S1}	[Nm]
... at speed	n	[min ⁻¹]
Current	I_{S1}	[A]
Power	$P_{S6-60\%}$	[kW]
Torque	$M_{S6-60\%}$	[Nm]
... at speed	n	[min ⁻¹]
Current	$I_{S6-60\%}$	[A]

HV-X 100 - 30000/9			
100			
30000			
45			
D 28/43			
43			
80			
74			
200 V	350 V	460 V	
1000			
200	350	460	
7,5			
3,41			
21000			
49	28	21	
9			
4,09			
21000			
53	30	23	

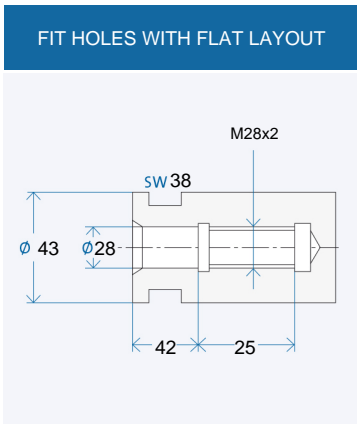
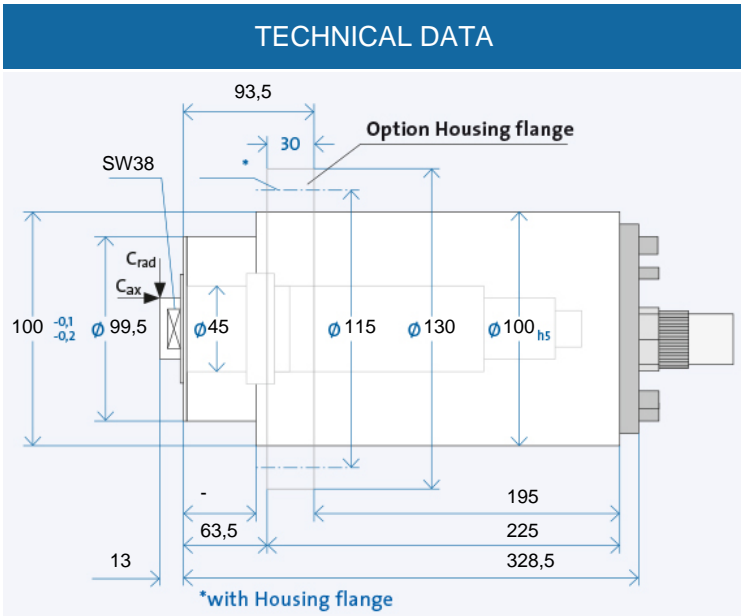

Electrical connection		
Plug type	MAC	
Straight plug connection	+	+
Coil plug connector	o	o
Fixed cable XXm	o	o
Coolant feed through the shaft		
Low pressure (du)	o	
High-pressure (dh)	-	
Sensors		
Rotary encoder	-	
Speed sensor	+	
Housing		
Cylindrical housing	+	
Cylindrical housing with flange	o	
Block housing	x	
Air-tight seal	o	

Coolant feed through the shaft		
Low pressure (du)	o	
High-pressure (dh)	-	
Sensors		
Rotary encoder	-	
Speed sensor	+	
Housing		
Cylindrical housing	+	
Cylindrical housing with flange	o	
Block housing	x	
Air-tight seal	o	

¹⁾ Minimum required starting voltage for the frequency converter.

- + Standard
- o Optional
- x Upon request

Ordering information:

HV-X 100 - 30000/9
 R is for clockwise, L for counter-clockwise
 + Desired options

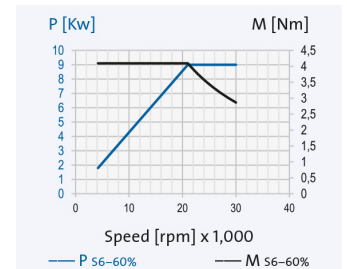

The data currently provided on the internet apply. Further and detailed information is provided in the GMN 2508 catalogue.

HV-X 100 - 30000/9

Grinding quills

GMN produces grinding quills with high round and flat face accuracy for all available GMN grinding mandrel receivers.

FIG. 1: CEMENTED (KI)

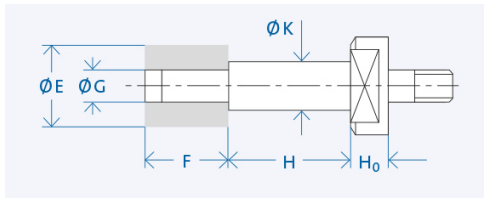

FIG. 2: WITH ADJUSTMENT SCREW (PS)

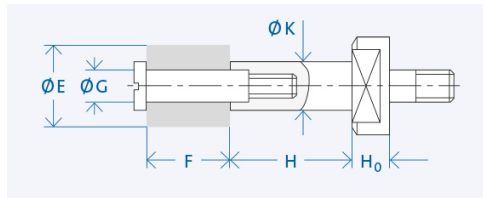
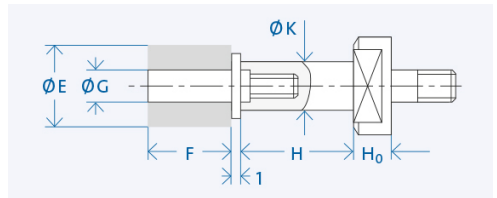
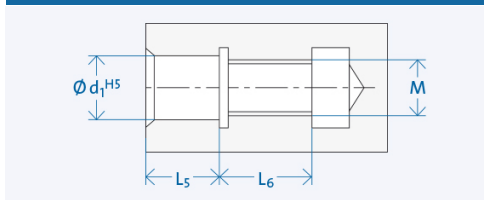

FIG. 3: FOR GRINDING WHEELS ON THREADED PIN (PL)*



FITTING HOLE FOR FIG. 2 AND 3



d ₁	M	L ₅	L ₆
4	M3	5	8
6	M5	7	11
8	M6	9	12
10	M8	12	14
13	M12	13	17

Interface	K [mm]	H [mm]	Wheel E x F [mm]	G [mm]	Grinding wheel attachment	H ₀ [mm]
D 28/43	16	40	25 x 25	10	PS/PL	12
	20	50	32 x 25	13	PS/PL	
	32	63	50 x 40	20	MU	

Ordering information:

[Mandrel Ø K] x [Mandrel length H] - [Grinding wheels ø G] x [Grinding wheel width F] [Interface] [Mandrel fixation]

Example: Grinding quill 16 x 40 - 10 x 25 D16/28 PS

Semi-finished goods

GMN semi-finished products allow the individual adaptation of the tool interface for any connections.

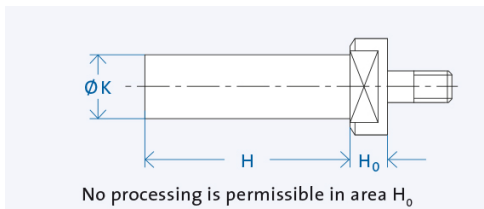

d ₁	K [mm]	H [mm]
D 28/43	48	240

Ordering information: »Semi-finished goods« [Shaft Ø K] x [Shaft length H] [Interface]

Example: Semi-finished goods 34 x 180 D16/33

Lubrication system

The electronically controlled PRELUB lubrication unit is optimally adapted to the oil-air lubricated GMN spindles and guarantees a long service life.



Cooling system

GMN cooling units ensure precisely adjustable temperature and quantity delivery of the coolant and achieve consistently low operating temperatures.



Cable and plug

Ready-made cables with B048, B049, GA, MAC, D500 and STK plugs are available on request. For the spindle/converter connection, GMN supplies UL/CSA approved electrical cables suitable for use in drag chains.

