

Spindle ball bearing S 6020 C TA P4+

16.07.2024



Components

Bearing designation:	S 6020 C TA
Bearing design:	S
Series / size:	6020
Ball material:	Steel 100Cr6
Cage:	TA
Seal:	2RZ upon request
Precision:	P4+
Main dimensions [d x D x B]:	100 x 150 x 24 mm

Load data

Static load capacity	C_{0r} : 84000 N
Dynamic load capacity	C_r : 78000 N
Fatigue load limit	C_U : 3876 N
Speed limit	n_{grease} : 10125 1/min
Speed limit	n_{oil} : 13500 1/min
Light preload	L: 400 N
Axial rigidity	C_{ax} : 118 N/ μ m
Medium preload	M: 1190 N
Axial rigidity	C_{ax} : 192 N/ μ m
Heavy preload	S: 2380 N
Axial rigidity	C_{ax} : 271 N/ μ m
Spring preload	Ff: 4220 N (for n_{max})

Geometrical Data

Bore diameter	d: 100 mm	Oiling nozzle position	d_f : 120.6 mm
Outer diameter	D: 150 mm	Pitch circle diameter	d_m : 125 mm
Width of single bearing	B: 24 mm	Inner diameter of outer ring	D_1 : 134.2 mm
Ball diameter	D_w : 15.081 mm	Undercut of associated component	$r_{a \max}$: 1.5 mm
Number of balls	Z: 22	Undercut of associated component (open side)	$r_{b \max}$: 0.6 mm
Chamfer (min)	$r_{1,2 \min}$: 1.5 mm	Abutment diameter inner ring	$d_{a,b \min}$: 108.9 mm
Chamfer (min), open side	$r_{3,4 \min}$: 0.6 mm	Abutment diameter outer ring	$D_{a,b \max}$: 142.4 mm
Outer diameter of inner ring	d_1 : 115.8 mm	Inner diameter of outer ring (open side)	D_2 : 140.3 mm
Outer diameter of inner ring (open side)	d_2 : -	Bearing weight	m: 1.25 kg
		Contact angle	Alpha 0: 15°

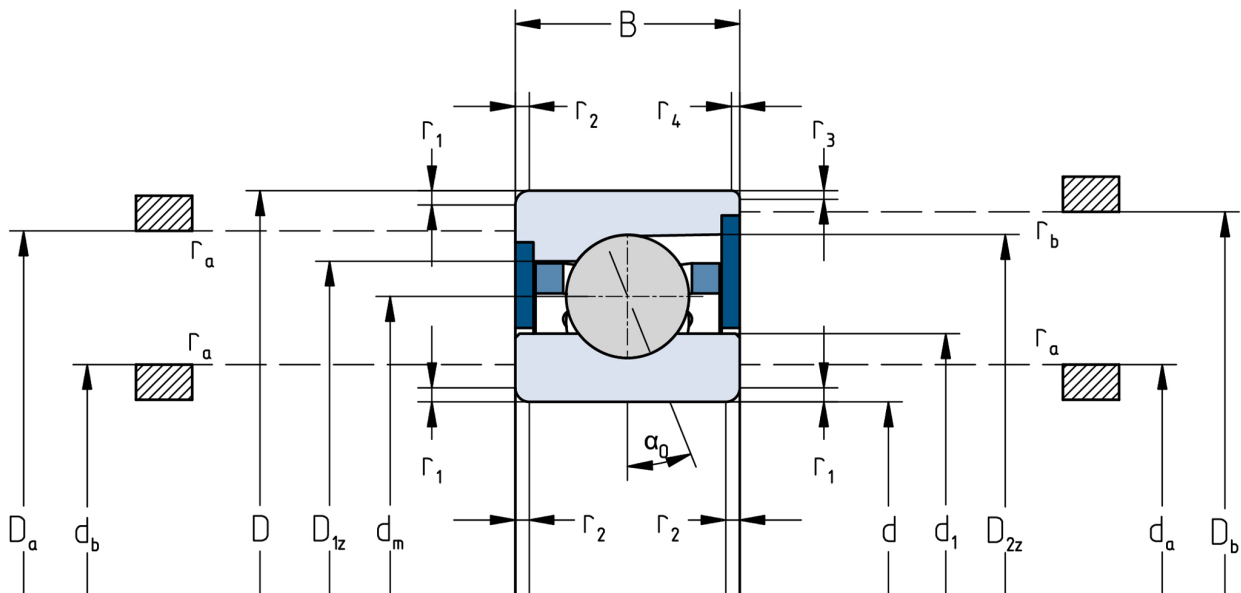

The given speed limits apply to individual bearings with spring preload. Correction factors must be considered for all properties which deviate from this.