

# TSAV 100 x 630

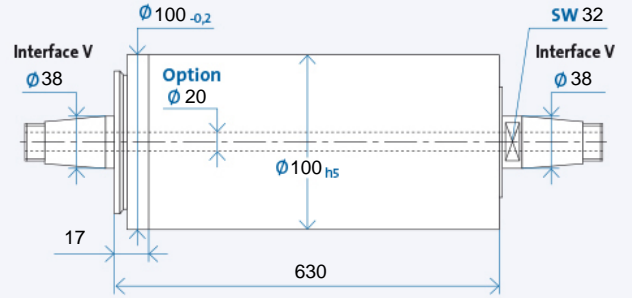

## Technical data



Spindle shaft bore is optional

## Maximum speed $n_{max}$ [ $min^{-1}$ ]\* for bearing types:

Standard	5500
Modified (optional)	10000

\* without tool

Ordering information: TSAV 100 x 630 R is for clockwise, L for counter-clockwise

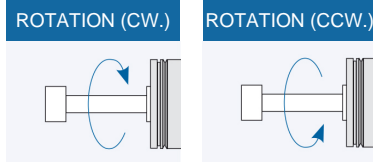

## Tool interface

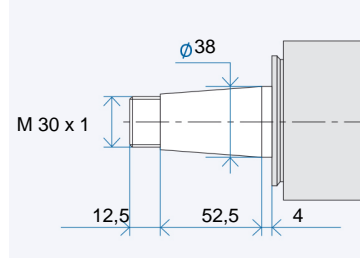

Tool interface: fitting bores with flat contact face acc. to GMN precision standards

## Pulley interface

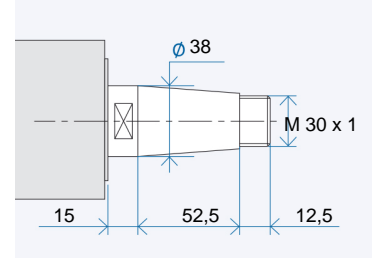

Pulley interface: taper 1 : 7,5 nominal value, included angle acc. to GMN precision standards

## Accessories

## Pulleys

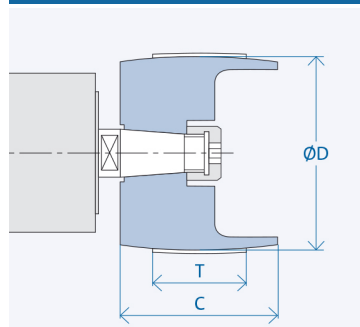

Interface	Dimensions [mm]		
	D	C	T
V 38	80	80	70
	125	80	70

Ordering information pulley: VX<sub>1</sub>-X<sub>2</sub>  
 X<sub>1</sub>: Interface: 12/15/...  
 X<sub>2</sub>: Figure from column D  
 Puller for pulley: VX<sub>1</sub>/...

## Anti-rotation slot

Option from TSAV 50 up to TSAV 80  
 Standard from TSAV 100

The lock pin is not included in the scope of delivery and must be ordered separately.

## Optional equipment (on request)

- Balancing systems (manual or automatic)
- Special seal
- Housing design

# TSAV 100 x 630



## Accessories

### TSAV Grinding wheel flanges MS

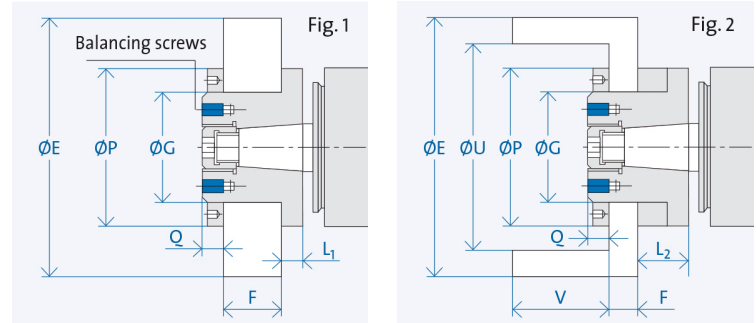

Interface		Dimensions [mm]				Grinding wheel [mm]					Speed [min <sup>-1</sup> ] at v <sub>c</sub> =35 m/s <sup>2)</sup>
		P	Q	L <sub>1</sub>	L <sub>2</sub>	E	G	F	U	V	
V38	Fig. 1	110	13,5	13	-	175	76	30 - 40	-	-	3800
	Fig. 2	110	13,5	13	30	175	76	13 - 23	190	100	3800

### TSAV Grinding wheel flanges SN

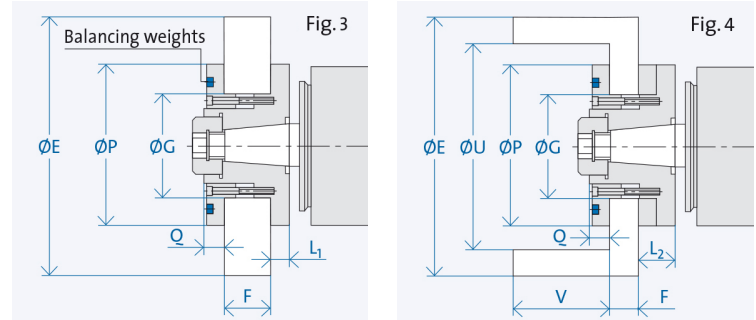

Interface		Dimensions [mm]				Grinding wheel [mm]					Speed [min <sup>-1</sup> ] at v <sub>c</sub> =35 m/s <sup>2)</sup>
		P	Q	L <sub>1</sub>	L <sub>2</sub>	E	G	F	U	V	
V38	Fig. 3	110	13	13	-	250	76	20 - 40	-	-	2600
	Fig. 4	110	13	13	28	250	76	5 - 25	190	100	2600

<sup>2)</sup> Attention! Wheel selection must be in accordance with the manufacturer's recommendation for maximum speed.

Ordering information flange: V X<sub>1</sub>/X<sub>2</sub>/X<sub>3</sub>/X<sub>4</sub>

X<sub>1</sub>: Interface: 12/15/...

X<sub>2</sub>: MS = Flange style MS  
SN = Flange style SN

X<sub>3</sub>: G = Straight grinding wheel  
T = Cup grinding wheel

X<sub>4</sub>: K = Corundum grinding wheel, Ø G<sub>17</sub>  
D = Diamond or CBN grinding wheel, Ø G<sub>14</sub>

Puller for flange: V X<sub>1</sub>/X<sub>2</sub>

Balancing quill for flange: V X<sub>1</sub>

### Anti-rotation slot

TSAV 50 up to TSAV 80:  
Option: Flange style MS  
From TSAV 100:  
Standard: Flange style SN

The lock pin is not included in the scope of delivery and must be ordered separately.