

Spindle ball bearing HY SM 6011 C TA P4+

16.07.2024



Components

Bearing designation:	HY SM 6011 C TA
Bearing design:	SM
Series / size:	6011
Ball material:	Ceramic
Cage:	TA
Seal:	2RZ upon request
Precision:	P4+ (UP+ Upon request)
Main dimensions [d x D x B]:	55 x 90 x 18 mm

Load data

Static load capacity	C_{0r} : 15000 N
Dynamic load capacity	C_r : 23100 N
Fatigue load limit	C_U : 568 N
Speed limit	n_{grease} : 25500 1/min
Speed limit	n_{oil} : 34000 1/min
Light preload	L: 115 N
Axial rigidity	C_{ax} : 57 N/ μ m
Medium preload	M: 350 N
Axial rigidity	C_{ax} : 88 N/ μ m
Heavy preload	S: 700 N
Axial rigidity	C_{ax} : 120 N/ μ m
Spring preload	Ff: 620 N (for n_{max})

Geometrical Data

Bore diameter	d: 55 mm	Oiling nozzle position	d_f : 69.8 mm
Outer diameter	D: 90 mm	Pitch circle diameter	d_m : 72.5 mm
Width of single bearing	B: 18 mm	Inner diameter of outer ring	D_1 : 78.2 mm
Ball diameter	D_w : 9.525 mm	Undercut of associated component	$r_{a max}$: 1 mm
Number of balls	Z: 20	Undercut of associated component (open side)	$r_{b max}$: 1 mm
Chamfer (min)	$r_{1,2 min}$: 1.1 mm	Abutment diameter inner ring	$d_{a,b min}$: 61.4 mm
Chamfer (min), open side	$r_{3,4 min}$: 1 mm	Abutment diameter outer ring	$D_{a,b max}$: 84.6 mm
Outer diameter of inner ring	d_1 : 66.8 mm	Inner diameter of outer ring (open side)	D_2 : 82.2 mm
Outer diameter of inner ring (open side)	d_2 : -	Bearing weight	m: 0.345 kg
		Contact angle	Alpha 0: 15°

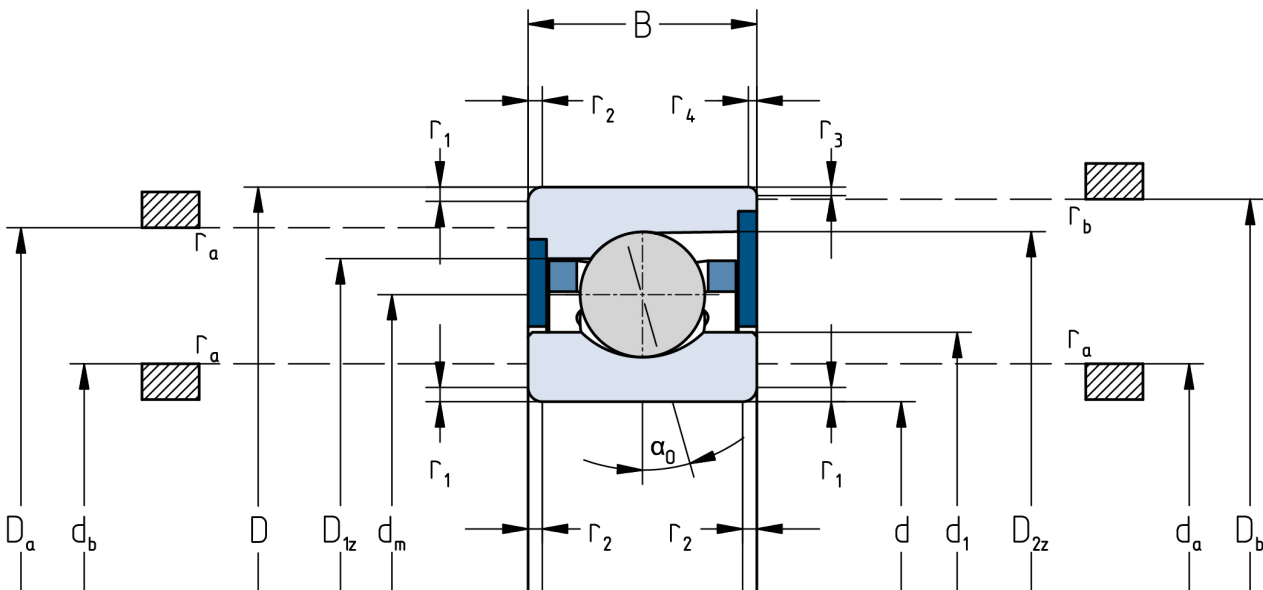

The given speed limits apply to individual bearings with spring preload. Correction factors must be considered for all properties which deviate from this.