

Spindle ball bearing HY SM 61902 C TXM P4+ 16.07.2024



Components

Bearing designation:	HY SM 61902 C TXM
Bearing design:	SM
Series / size:	61902
Ball material:	Ceramic
Cage:	TXM
Precision:	P4+
Main dimensions [d x D x B]:	15 x 28 x 7 mm

Load data

Static load capacity	C_{0r} : 1510 N
Dynamic load capacity	C_r : 3600 N
Fatigue load limit	C_U : 57 N
Speed limit	n_{grease} : 86250 1/min
Speed limit	n_{oil} : 115000 1/min
Light preload	L: 18 N
Axial rigidity	C_{ax} : 16 N/ μ m
Medium preload	M: 55 N
Axial rigidity	C_{ax} : 26 N/ μ m
Heavy preload	S: 110 N
Axial rigidity	C_{ax} : 35 N/ μ m
Spring preload	Ff: 60 N (for n_{max})

Geometrical Data

Bore diameter	d: 15 mm	Oiling nozzle position	d_T : 20.2 mm
Outer diameter	D: 28 mm	Pitch circle diameter	d_m : 21.5 mm
Width of single bearing	B: 7 mm	Inner diameter of outer ring	D_1 : 24.3 mm
Ball diameter	D_w : 3.969 mm	Undercut of associated component	$r_{a max}$: 0.3 mm
Number of balls	Z: 13	Undercut of associated component (open side)	$r_{b max}$: 0.3 mm
Chamfer (min)	$r_{1,2 min}$: 0.3 mm	Abutment diameter inner ring	$d_{a,b min}$: 17.1 mm
Chamfer (min), open side	$r_{3,4 min}$: 0.3 mm	Abutment diameter outer ring	$D_{a,b max}$: 26.3 mm
Outer diameter of inner ring	d_1 : 18.7 mm	Inner diameter of outer ring (open side)	D_2 : 25.5 mm
Outer diameter of inner ring (open side)	d_2 : -	Bearing weight	m: 0.013 kg
		Contact angle	Alpha 0: 15°

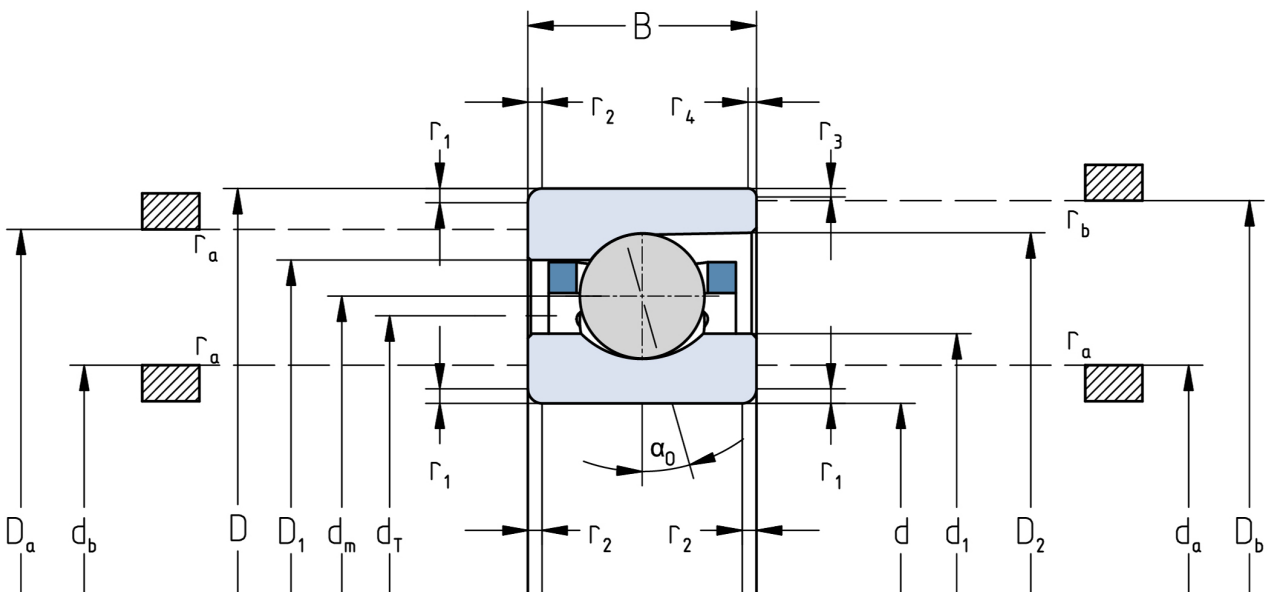

The given speed limits apply to individual bearings with spring preload. Correction factors must be considered for all properties which deviate from this.