

TSP 60 x 160

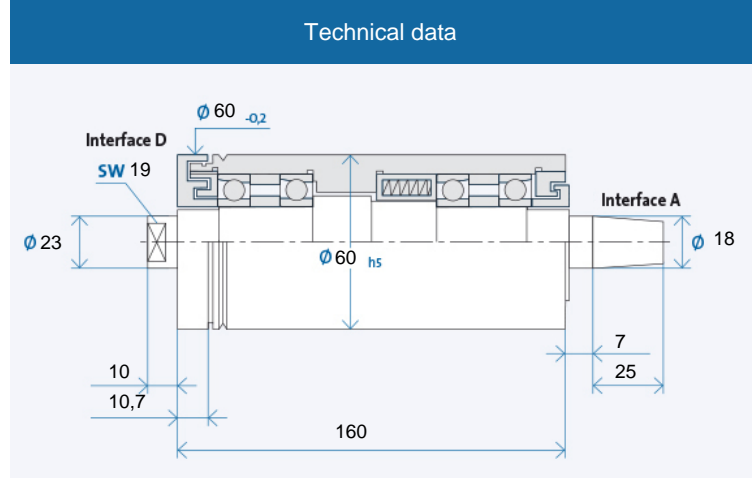

Maximum speed n_{max} [min⁻¹]* for bearing types:

Steel (steel)	30000
Hybrid (optional)	35000

* without tool

Ordering information: TSP 60 x 160 R is for clockwise, L for counter-clockwise

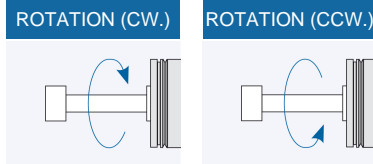

Accessories

Pulleys

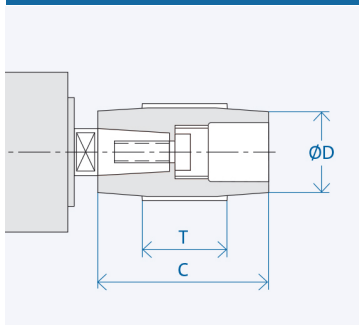

Interface	Dimensions [mm]		
	D	C	T
A 18	25	60	40
	32	60	40
	40	60	40
	100	60	40

Ordering information pulley: AX₁-X₂
 X₁: Interface: 10/13/...
 X₂: Figure from column D
 Puller for pulley: AX₁/...

TSP Collet chuck

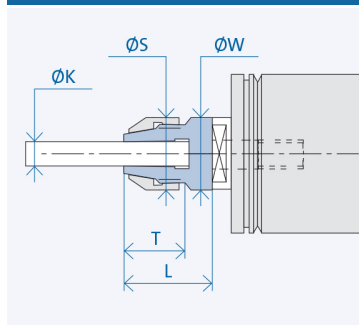

Interface	Dimensions [mm]					
	K	T	L	S	W	
D 14/23	6	20	30	23	23	

Ordering information collet chuck: D 14/23/(K)
 (K) = Clamping diameter

Tool interface

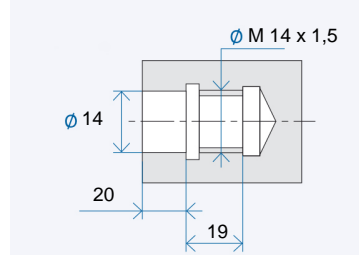

Tool interface: fitting bores with flat contact face acc. to GMN precision standards

Pulley interface

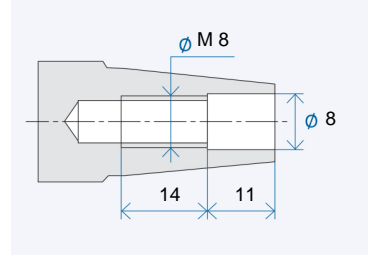

Pulley interface: taper 1 : 7,5 nominal value, included angle acc. to GMN precision standards

TSP Grinding quill – semifinished

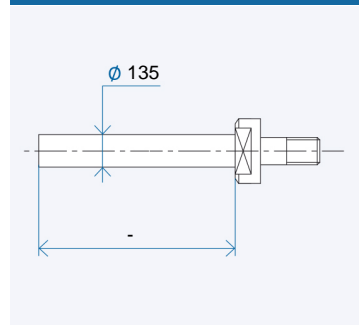

Ordering information semifinished: DX₁/X₂
 X₁/X₂: Interface 08/14/...