

Spindle ball bearing HY SM 61916 C TA P4+

16.07.2024



Components

Bearing designation:	HY SM 61916 C TA
Bearing design:	SM
Series / size:	61916
Ball material:	Ceramic
Cage:	TA
Seal:	2RZ upon request
Precision:	P4+
Main dimensions [d x D x B]:	80 x 110 x 16 mm

Load data

Static load capacity	C_{0r} : 19400 N
Dynamic load capacity	C_r : 25500 N
Fatigue load limit	C_U : 736 N
Speed limit	n_{grease} : 19875 1/min
Speed limit	n_{oil} : 26500 1/min
Light preload	L: 130 N
Axial rigidity	C_{ax} : 97 N/ μ m
Medium preload	M: 390 N
Axial rigidity	C_{ax} : 145 N/ μ m
Heavy preload	S: 780 N
Axial rigidity	C_{ax} : 191 N/ μ m
Spring preload	Ff: 1030 N (for n_{max})

Geometrical Data

Bore diameter	d: 80 mm	Oiling nozzle position	d_f : 92.3 mm
Outer diameter	D: 110 mm	Pitch circle diameter	d_m : 95 mm
Width of single bearing	B: 16 mm	Inner diameter of outer ring	D_1 : 100.8 mm
Ball diameter	D_w : 9.525 mm	Undercut of associated component	$r_{a max}$: 0.6 mm
Number of balls	Z: 25	Undercut of associated component (open side)	$r_{b max}$: 0.3 mm
Chamfer (min)	$r_{1,2 min}$: 0.6 mm	Abutment diameter inner ring	$d_{a,b min}$: 84.9 mm
Chamfer (min), open side	$r_{3,4 min}$: 0.3 mm	Abutment diameter outer ring	$D_{a,b max}$: 105.7 mm
Outer diameter of inner ring	d_1 : 89.4 mm	Inner diameter of outer ring (open side)	D_2 : 104.6 mm
Outer diameter of inner ring (open side)	d_2 : -	Bearing weight	m: 0.31 kg
		Contact angle	Alpha 0: 19°

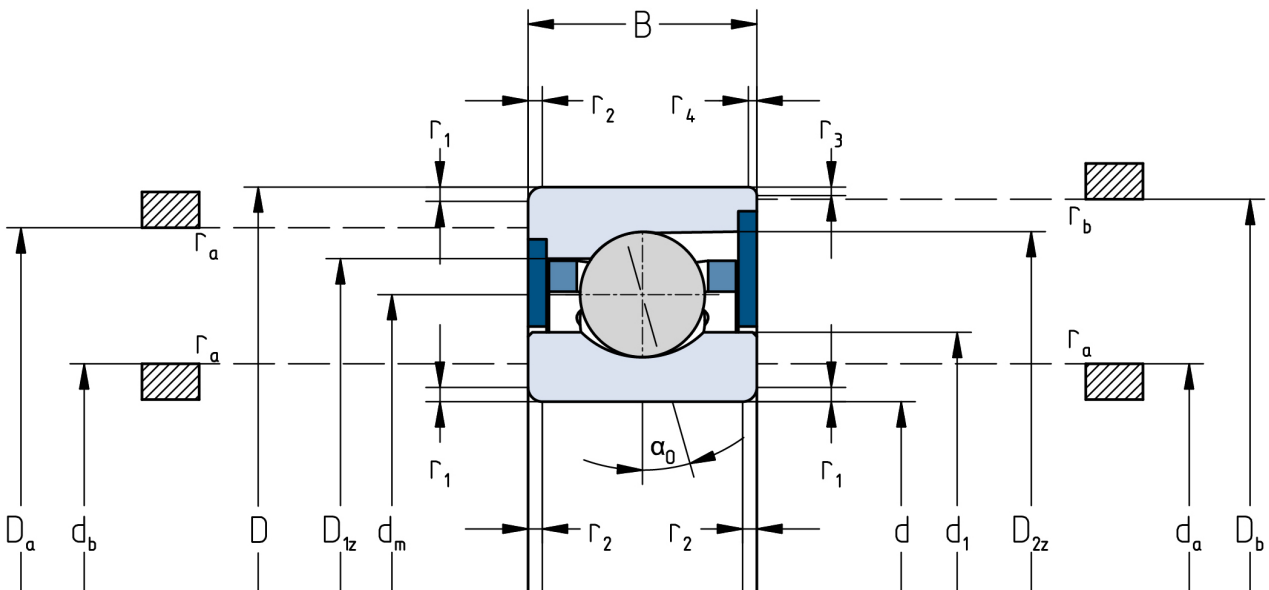

The given speed limits apply to individual bearings with spring preload. Correction factors must be considered for all properties which deviate from this.