

TSP 50 x 160

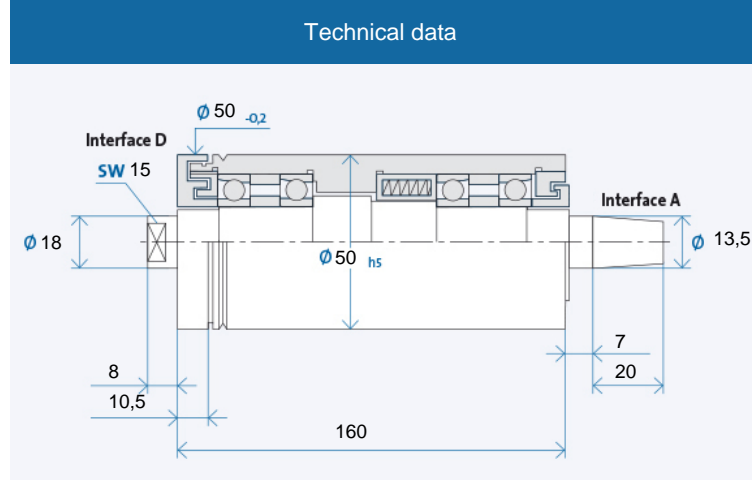

Maximum speed n_{max} [min ⁻¹]* for bearing types:	
Steel (steel)	35000
Hybrid (optional)	42000

* without tool

Ordering information: TSP 50 x 160 R is for clockwise, L for counter-clockwise

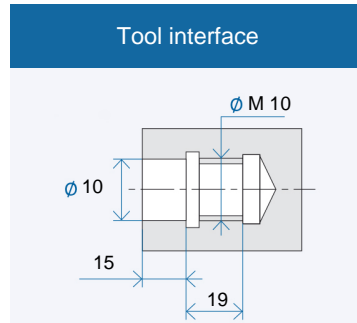
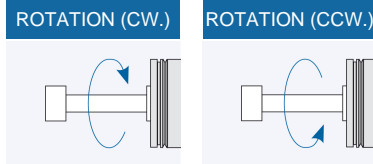

Tool interface: fitting bores with flat contact face acc. to GMN precision standards

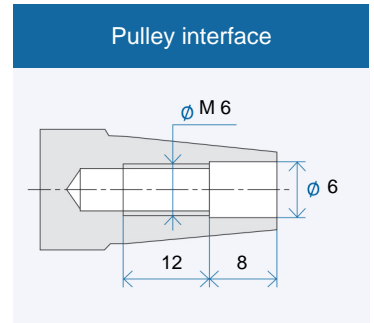

Pulley interface: taper 1 : 7,5 nominal value, included angle acc. to GMN precision standards

Accessories

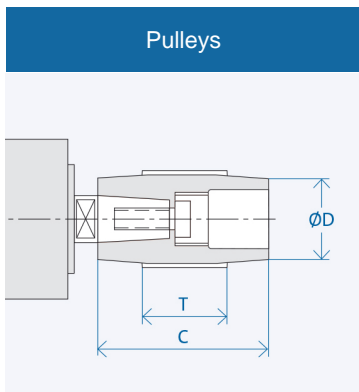

Interface	Dimensions [mm]		
	D	C	T
A 13	20	50	30
	25	50	30
	32	50	30
	80	50	30

Ordering information pulley: AX₁-X₂
 X₁: Interface: 10/13/...
 X₂: Figure from column D
 Puller for pulley: AX₁/...

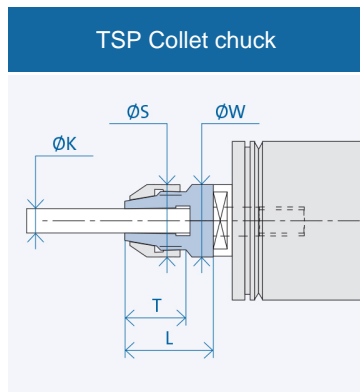

Interface	Dimensions [mm]					
	K	T	L	S	W	
D 10/18	6	20	30	18	18	

Ordering information collet chuck: D 10/18/(K)
 (K) = Clamping diameter

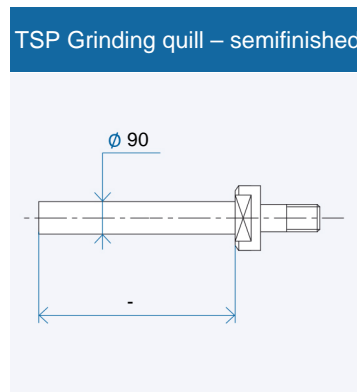

Ordering information semifinished: DX₁/X₂
 X₁/X₂: Interface 08/14/...