

TSP 100 x 250

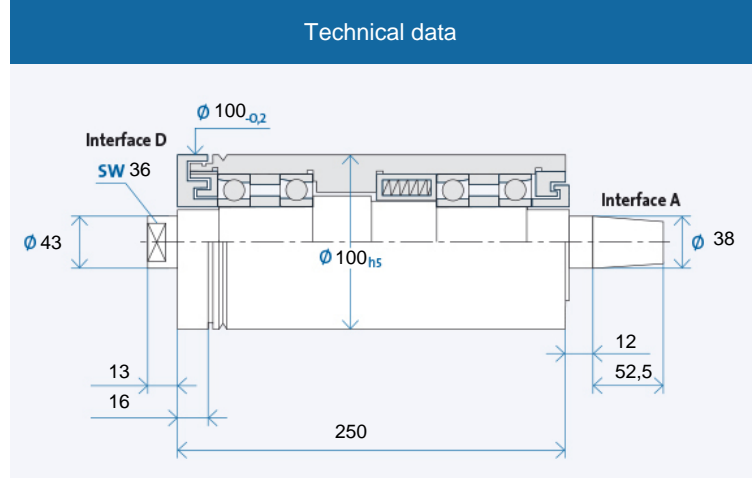

Maximum speed n_{max} [min-1]* for bearing types:	
Steel (steel)	15000
Hybrid (optional)	20000

* without tool

Ordering information: TSP 100 x 250 R is for clockwise, L for counter-clockwise

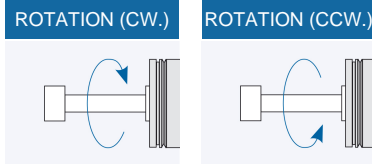

Accessories

Pulleys

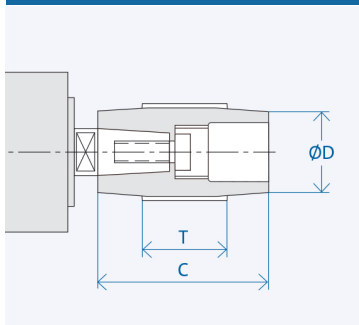

Interface	Dimensions [mm]		
	D	C	T
A 38	50	80	60
	63	80	60
	160	80	60

Ordering information pulley: AX₁-X₂

X₁: Interface: 10/13/...

X₂: Figure from column D

Puller for pulley: AX₁/...

TSP Grinding quill – semifinished

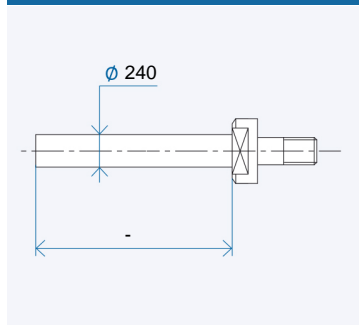

Ordering information semifinished: DX₁/X₂
X₁/X₂: Interface 08/14/...

Tool interface

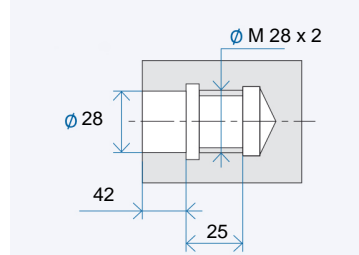

Tool interface: fitting bores with flat contact face acc. to GMN precision standards

Pulley interface

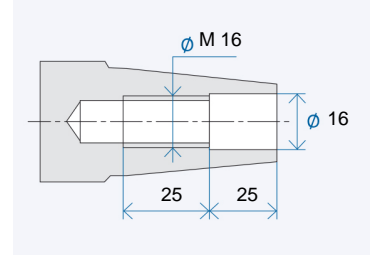

Pulley interface: taper 1 : 7,5 nominal value, included angle acc. to GMN precision standards