

# Freewheel Clutch Insert Element FR 448 M



Item number 300602

## Components

<b>Freewheel clutch</b>	<b>Insert Element FE 400 M</b>
· Rings	Bearing steel, hardened and ground
· Inner ring	Press fit
· Outer ring	Press fit

## Key values

Ø Shaft d:	35 mm
Ø Hub D:	53 mm
Installed width W:	12 mm
Torque $T_{nom}$ :	272 Nm
Number of sprags:	46
Speed $n_{max}$ :	4300 rpm
Weight:	0.0883 kg
Operating temperature:	max. 140°C

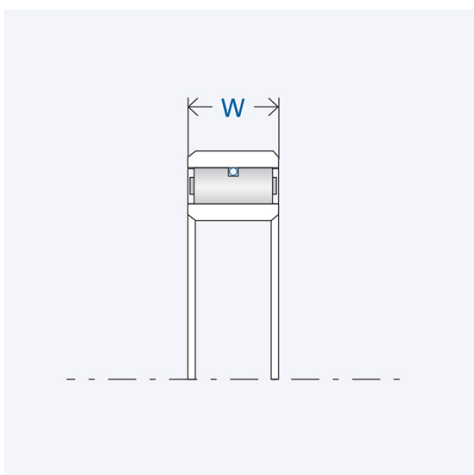
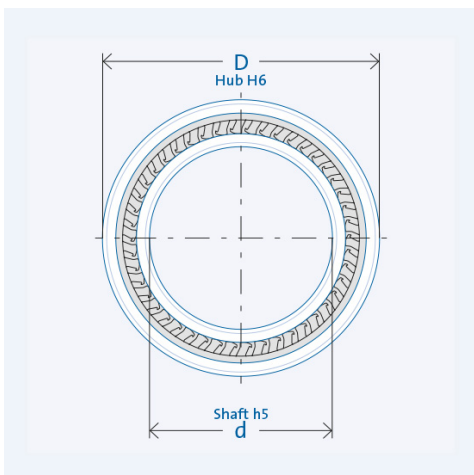

## Lubrication

Oil or grease lubrication  
 Delivered with corrosion protection.  
 Operative grease filling on request.

## Installation

### Installation tolerances

Shaft h5; hub H6

### Constraints

The freewheel clutch insert element requires axial constraints on both sides.

### Mating parts

Hardening and grinding of the mating parts is not necessary. Thoroughly clean (grease free) the mating parts in the vicinity of the freewheel clutch as well as the freewheel clutch's rings before making the press fit.

### Bearing

Freewheel clutch insert elements are not self-centering. External bearing support to define the gap between mating parts (Shaft and housing) is necessary.