

HSX 170 - 24000/21

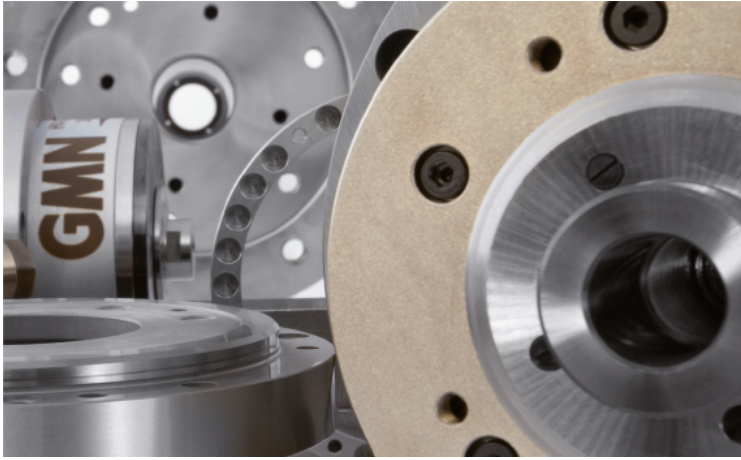

Technical data		
∅ Spindle housing	A	[mm]
Speed max.	n_{max}	[min ⁻¹]
Bearing; front	W_1	[mm]
Tool interface		
∅ Flat layout	W	[mm]
Static rigidity		
axial	C_{ax}	[N/μm]
radial	C_{rad}	[N/μm]
Motor realization		
Frequency max.	f_{max}	[Hz]
Converter voltage ¹⁾		[V]
Power	P_{S1}	[kW]
Torque	M_{S1}	[Nm]
... at speed	n	[min ⁻¹]
Current	I_{S1}	[A]
Power	$P_{S6-60\%}$	[kW]
Torque	$M_{S6-60\%}$	[Nm]
... at speed	n	[min ⁻¹]
Current	$I_{S6-60\%}$	[A]

HSX 170 - 24000/21			
170			
24000			
65			
D 36/63			
63			
130			
231			
200 V	350 V	460 V	
800			
200	350	460	
19			
20,2			
9000			
82	47	36	
21			
22,3			
9000			
93	53	40	

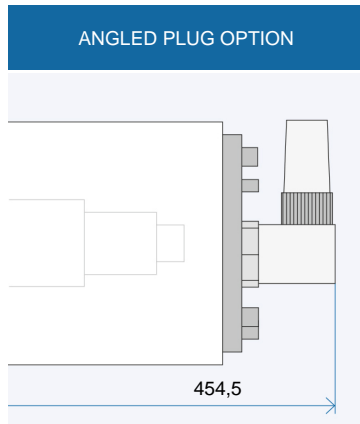
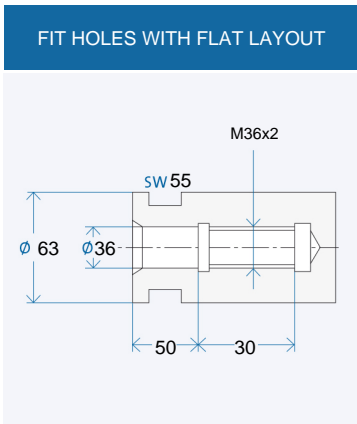
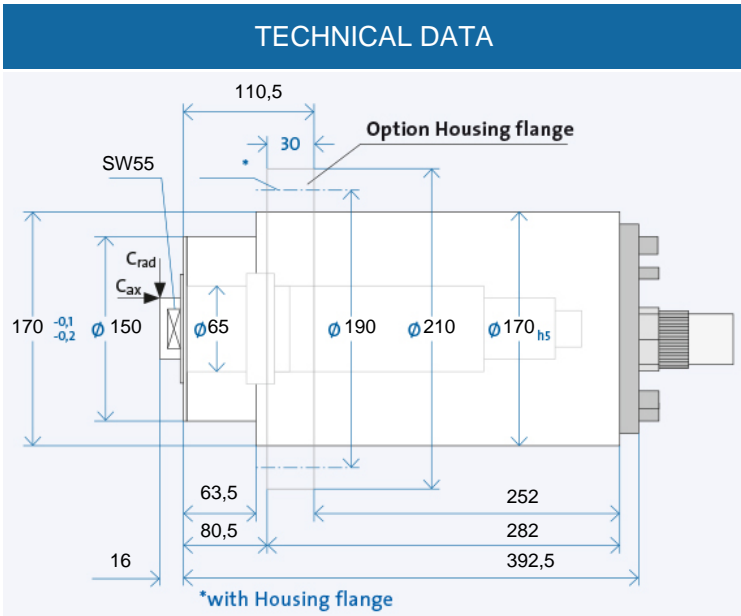

Electrical connection		
Plug type	Straight plug connection	
Coil plug connector	Fixed cable XXm	
Coolant feed through the shaft		
Low pressure (du)	-	
High-pressure (dh)	x	
Sensors		
Rotary encoder	x	
Speed sensor	+	
Housing		
Cylindrical housing	+	
Cylindrical housing with flange	o	
Block housing	x	
Air-tight seal	o	

MAC	MAC	MAC
+	+	+
o	o	o
o	o	o
-		
x		
x		
+		
+		
o		
x		
o		

¹⁾ Minimum required starting voltage for the frequency converter.

- + Standard
- o Optional
- x Upon request

Ordering information:
 HSX 170 - 24000/21
 R is for clockwise, L for counter-clockwise
 + Desired options

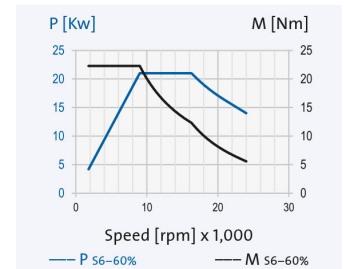

The data currently provided on the internet apply. Further and detailed information is provided in the GMN 2508 catalogue.

HSX 170 - 24000/21

Grinding quills

GMN produces grinding quills with high round and flat face accuracy for all available GMN grinding mandrel receivers.

FIG. 1: CEMENTED (KI)

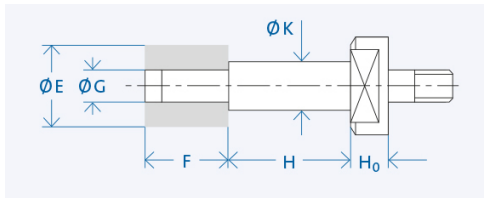

FIG. 2: WITH ADJUSTMENT SCREW (PS)

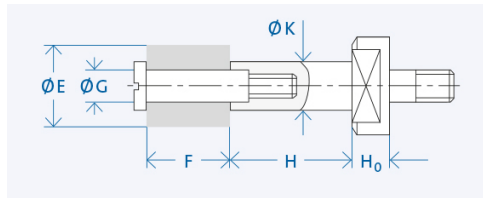
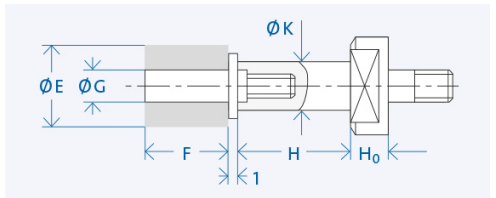
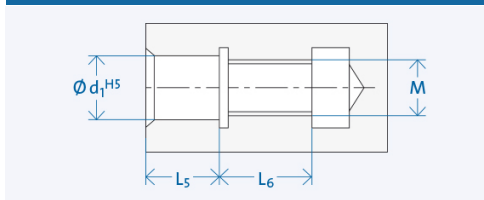

FIG. 3: FOR GRINDING WHEELS ON THREADED PIN (PL)*



FITTING HOLE FOR FIG. 2 AND 3



d ₁	M	L ₅	L ₆
4	M3	5	8
6	M5	7	11
8	M6	9	12
10	M8	12	14
13	M12	13	17

Interface	K [mm]	H [mm]	Wheel E x F [mm]	G [mm]	Grinding wheel attachment	H ₀ [mm]
D 36/63	25	50	40 x 32	16	MU	15
	32	63	50 x 40	20	MU	
	50	100	80 x 40	32	MU	

Ordering information:

[Mandrel Ø K] x [Mandrel length H] - [Grinding wheels ø G] x [Grinding wheel width F] [Interface] [Mandrel fixation]
Example: Grinding quill 16 x 40 - 10 x 25 D16/28 PS

Semi-finished goods

GMN semi-finished products allow the individual adaptation of the tool interface for any connections.

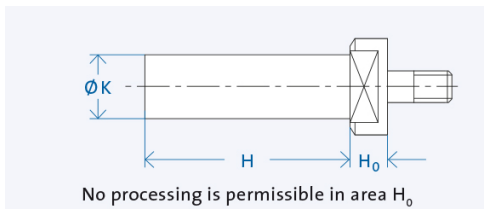

d ₁	K [mm]	H [mm]
D 36/63	63	150

Ordering information: »Semi-finished goods« [Shaft Ø K] x [Shaft length H] [Interface]
Example: Semi-finished goods 34 x 180 D16/33

Lubrication system

The electronically controlled PRELUB lubrication unit is optimally adapted to the oil-air lubricated GMN spindles and guarantees a long service life.



Cooling system

GMN cooling units ensure precisely adjustable temperature and quantity delivery of the coolant and achieve consistently low operating temperatures.



Cable and plug

Ready-made cables with B048, B049, GA, MAC, D500 and STK plugs are available on request. For the spindle/converter connection, GMN supplies UL/CSA approved electrical cables suitable for use in drag chains.

