

Spindle ball bearing HY S 61800 E TA P4+

16.07.2024



Components

Bearing designation:	HY S 61800 E TA
Bearing design:	S
Series / size:	61800
Ball material:	Ceramic
Cage:	TA
Precision:	P4+
Main dimensions [d x D x B]:	10 x 19 x 5 mm

Load data

Static load capacity	C_{0r} : 760 N
Dynamic load capacity	C_r : 1580 N
Fatigue load limit	C_U : 29 N
Speed limit	n_{grease} : 93750 1/min
Speed limit	n_{oil} : 125000 1/min
Light preload	L: 13 N
Axial rigidity	C_{ax} : 28 N/ μ m
Medium preload	M: 40 N
Axial rigidity	C_{ax} : 42 N/ μ m
Heavy preload	S: 80 N
Axial rigidity	C_{ax} : 55 N/ μ m
Spring preload	Ff: 55 N (for n_{max})

Geometrical Data

Bore diameter	d: 10 mm	Oiling nozzle position	d_T : 13.6 mm
Outer diameter	D: 19 mm	Pitch circle diameter	d_m : 14.5 mm
Width of single bearing	B: 5 mm	Inner diameter of outer ring	D_1 : 16.2 mm
Ball diameter	D_w : 2.381 mm	Undercut of associated component	$r_{a max}$: 0.3 mm
Number of balls	Z: 13	Undercut of associated component (open side)	$r_{b max}$: 0.2 mm
Chamfer (min)	$r_{1,2 min}$: 0.3 mm	Abutment diameter inner ring	$d_{a,b min}$: 11.6 mm
Chamfer (min), open side	$r_{3,4 min}$: 0.2 mm	Abutment diameter outer ring	$D_{a,b max}$: 17.7 mm
Outer diameter of inner ring	d_1 : 12.8 mm	Inner diameter of outer ring (open side)	D_2 : 16.9 mm
Outer diameter of inner ring (open side)	d_2 : -	Bearing weight	m: 0.005 kg
		Contact angle	Alpha 0: 25°

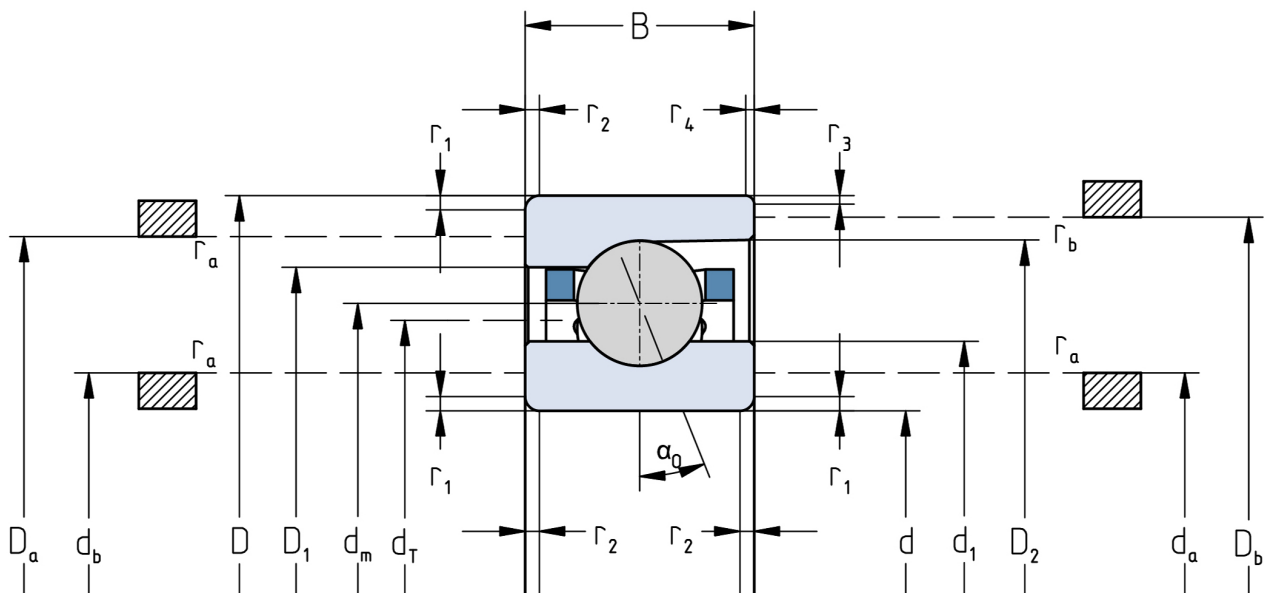

The given speed limits apply to individual bearings with spring preload. Correction factors must be considered for all properties which deviate from this.