

# Spindle ball bearing HY S 61800 C TA P4+

16.07.2024



## Components

Bearing designation:	HY S 61800 C TA
Bearing design:	S
Series / size:	61800
Ball material:	Ceramic
Cage:	TA
Precision:	P4+
Main dimensions [d x D x B]:	10 x 19 x 5 mm

## Load data

Static load capacity	$C_{0r}$ : 800 N
Dynamic load capacity	$C_r$ : 1660 N
Fatigue load limit	$C_U$ : 30 N
Speed limit	$n_{grease}$ : 108750 1/min
Speed limit	$n_{oil}$ : 145000 1/min
Light preload	L: 8 N
Axial rigidity	$C_{ax}$ : 11 N/ $\mu$ m
Medium preload	M: 25 N
Axial rigidity	$C_{ax}$ : 18 N/ $\mu$ m
Heavy preload	S: 50 N
Axial rigidity	$C_{ax}$ : 25 N/ $\mu$ m
Spring preload	Ff: 35 N (for $n_{max}$ )

## Geometrical Data

Bore diameter	d: 10 mm	Oiling nozzle position	$d_T$ : 13.6 mm
Outer diameter	D: 19 mm	Pitch circle diameter	$d_m$ : 14.5 mm
Width of single bearing	B: 5 mm	Inner diameter of outer ring	$D_1$ : 16.2 mm
Ball diameter	$D_w$ : 2.381 mm	Undercut of associated component	$r_{a max}$ : 0.3 mm
Number of balls	Z: 13	Undercut of associated component (open side)	$r_{b max}$ : 0.2 mm
Chamfer (min)	$r_{1,2 min}$ : 0.3 mm	Abutment diameter inner ring	$d_{a,b min}$ : 11.6 mm
Chamfer (min), open side	$r_{3,4 min}$ : 0.2 mm	Abutment diameter outer ring	$D_{a,b max}$ : 17.7 mm
Outer diameter of inner ring	$d_1$ : 12.8 mm	Inner diameter of outer ring (open side)	$D_2$ : 16.9 mm
Outer diameter of inner ring (open side)	$d_2$ : -	Bearing weight	m: 0.005 kg
		Contact angle	Alpha 0: 15°

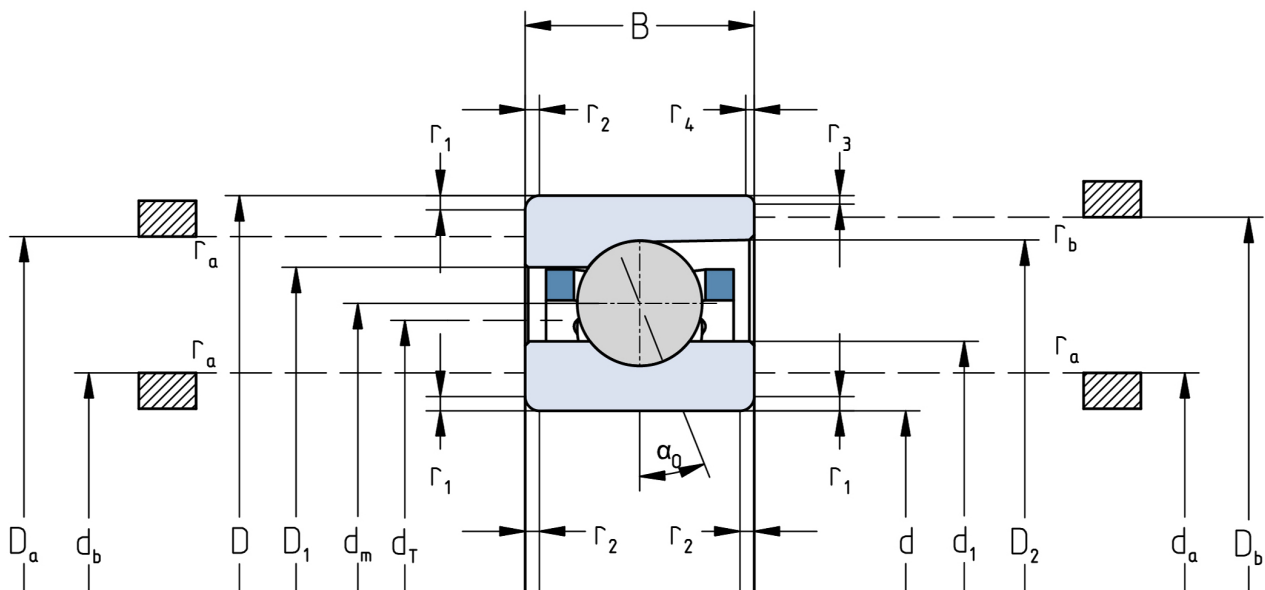

The given speed limits apply to individual bearings with spring preload. Correction factors must be considered for all properties which deviate from this.