

TSAV 140 x 400

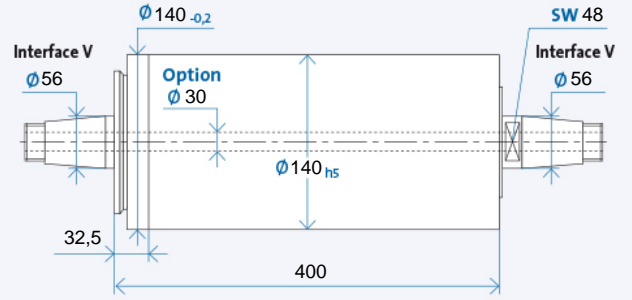

Technical data



Spindle shaft bore is optional

Maximum speed n_{max} [min^{-1}]* for bearing types:

Standard	3500
Modified (optional)	6000

* without tool

Ordering information: TSAV 140 x 400 R is for clockwise, L for counter-clockwise

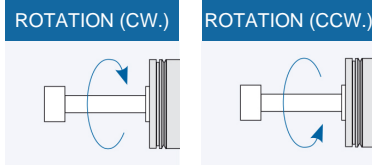

Tool interface

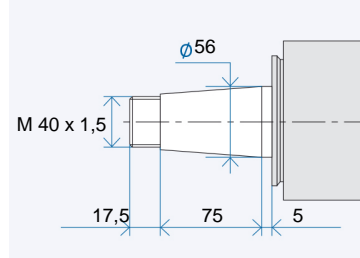

Tool interface: fitting bores with flat contact face acc. to GMN precision standards

Pulley interface

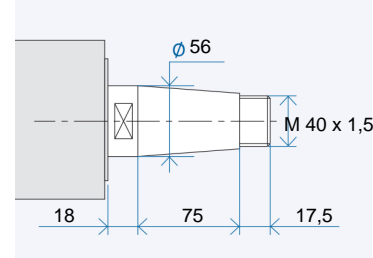

Pulley interface: taper 1 : 7,5 nominal value, included angle acc. to GMN precision standards

Accessories

Pulleys

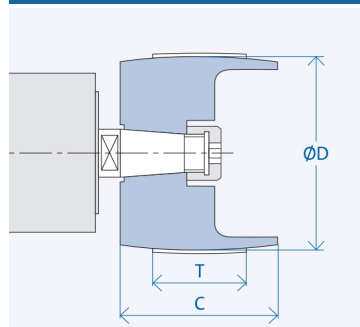

Interface	Dimensions [mm]		
	D	C	T
V 56	120	100	80
	210	100	80

Ordering information pulley: VX₁-X₂
 X₁: Interface: 12/15/...
 X₂: Figure from column D
 Puller for pulley: VX₁/...

Anti-rotation slot

Option from TSAV 50 up to TSAV 80
 Standard from TSAV 100

The lock pin is not included in the scope of delivery and must be ordered separately.

Optional equipment (on request)

- Balancing systems (manual or automatic)
- Special seal
- Housing design

TSAV 140 x 400



Accessories

TSAV Grinding wheel flanges MS

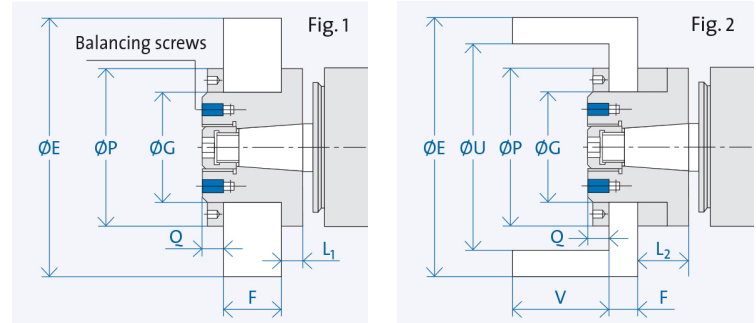

Interface	Dimensions [mm]				Grinding wheel [mm]					Speed [min ⁻¹] at v _c =35 m/s ²⁾
	P	Q	L ₁	L ₂	E	G	F	U	V	
V56 Fig. 1	140	14	18	-	250	76	46 - 60	-	-	2600

TSAV Grinding wheel flanges SN

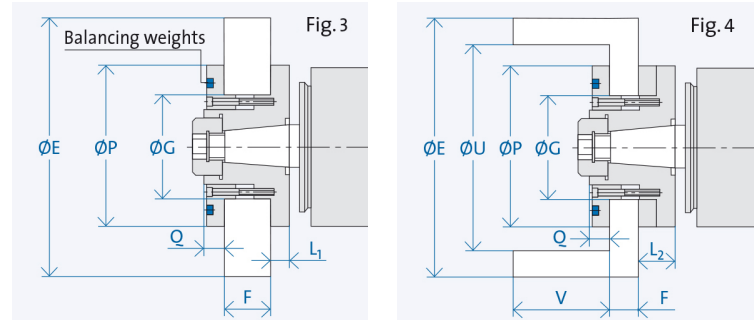

Interface	Dimensions [mm]				Grinding wheel [mm]					Speed [min ⁻¹] at v _c =35 m/s ²⁾
	P	Q	L ₁	L ₂	E	G	F	U	V	
V56 Fig. 3	180	18	18	-	450	127	32 - 60	-	-	1400
V56 Fig. 4	180	18	18	46	450	127	14 - 32	260	118	1400

²⁾ Attention! Wheel selection must be in accordance with the manufacturer's recommendation for maximum speed.

Ordering information flange: V X₁/X₂/X₃/X₄

X₁: Interface: 12/15/...

X₂: MS = Flange style MS

SN = Flange style SN

X₃: G = Straight grinding wheel

T = Cup grinding wheel

X₄: K = Corundum grinding wheel, Ø G₁₇

D = Diamond or CBN grinding wheel, Ø G_{n4}

Puller for flange: V X₁/X₂

Balancing quill for flange: V X₁

Anti-rotation slot

TSAV 50 up to TSAV 80:

Option: Flange style MS

From TSAV 100:

Standard: Flange style SN

The lock pin is not included in the scope of delivery and must be ordered separately.