

Spindle ball bearing HY S 61901 E TA P4+

16.07.2024



Components

Bearing designation:	HY S 61901 E TA
Bearing design:	S
Series / size:	61901
Ball material:	Ceramic
Cage:	TA
Precision:	P4+
Main dimensions [d x D x B]:	12 x 24 x 6 mm

Load data

Static load capacity	C_{0r} : 1530 N
Dynamic load capacity	C_r : 2950 N
Fatigue load limit	C_U : 58 N
Speed limit	n_{grease} : 78750 1/min
Speed limit	n_{oil} : 105000 1/min
Light preload	L: 25 N
Axial rigidity	C_{ax} : 41 N/ μ m
Medium preload	M: 75 N
Axial rigidity	C_{ax} : 62 N/ μ m
Heavy preload	S: 150 N
Axial rigidity	C_{ax} : 81 N/ μ m
Spring preload	Ff: 110 N (for n_{max})

Geometrical Data

Bore diameter	d: 12 mm	Oiling nozzle position	d_T : 16.5 mm
Outer diameter	D: 24 mm	Pitch circle diameter	d_m : 17.5 mm
Width of single bearing	B: 6 mm	Inner diameter of outer ring	D_1 : 19.6 mm
Ball diameter	D_w : 3.175 mm	Undercut of associated component	$r_{a max}$: 0.3 mm
Number of balls	Z: 13	Undercut of associated component (open side)	$r_{b max}$: 0.3 mm
Chamfer (min)	$r_{1,2 min}$: 0.3 mm	Abutment diameter inner ring	$d_{a,b min}$: 13.9 mm
Chamfer (min), open side	$r_{3,4 min}$: 0.3 mm	Abutment diameter outer ring	$D_{a,b max}$: 22.5 mm
Outer diameter of inner ring	d_1 : 15.4 mm	Inner diameter of outer ring (open side)	D_2 : 20.7 mm
Outer diameter of inner ring (open side)	d_2 : -	Bearing weight	m: 0.01 kg
		Contact angle	Alpha 0: 25°

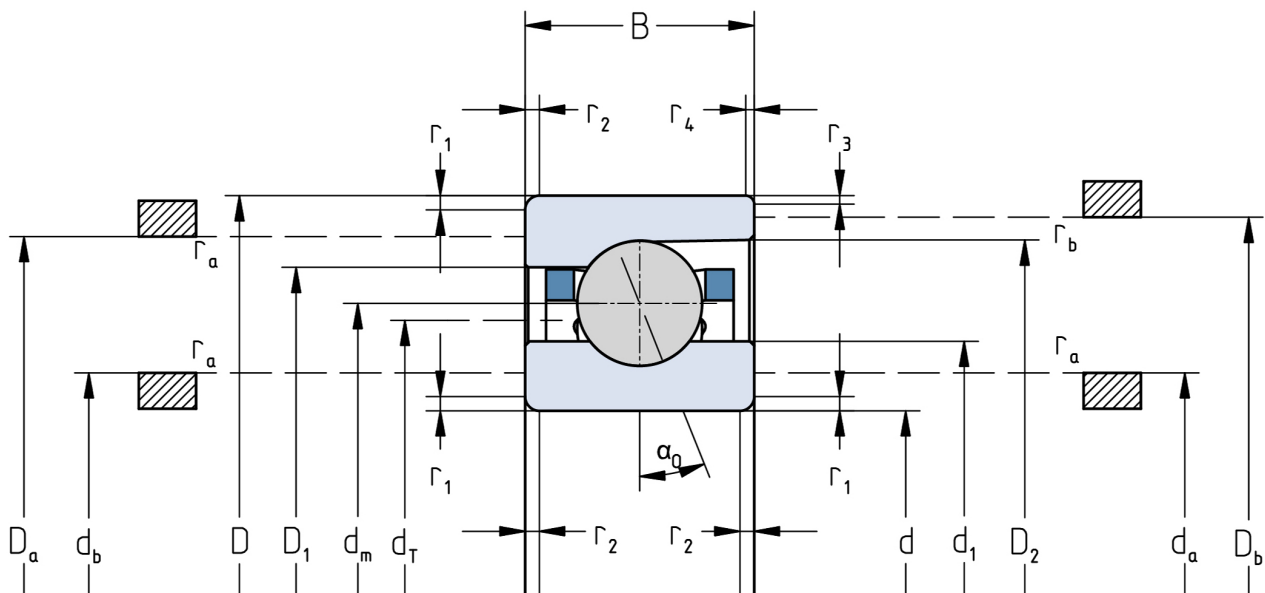

The given speed limits apply to individual bearings with spring preload. Correction factors must be considered for all properties which deviate from this.